

built for
industry

nabco

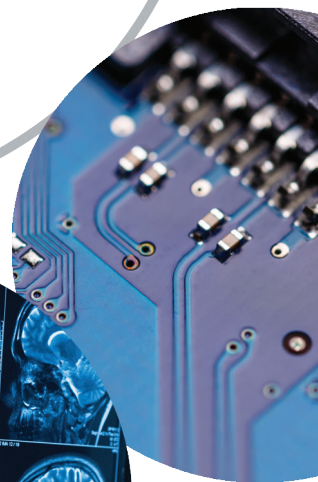
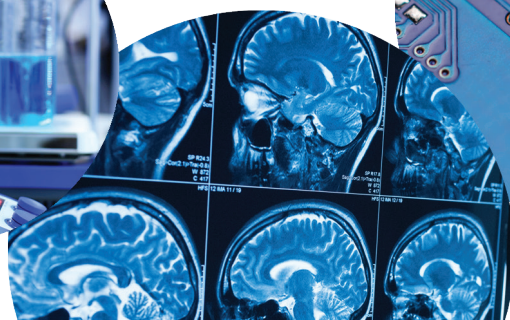
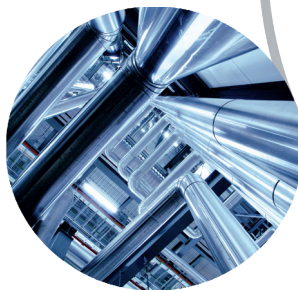

twin tower desiccant compressed air dryers

flow capacity: 200 - 10000 scfm (340 -16990 Nm³/hr)

D⁵

twin tower desiccant compressed air dryers

flow capacity: 200 - 10000 scfm (340 - 16990 Nm³/hr)

D⁵

Leading edge technology and hundreds of years of **experience**... nano-purification solutions, your world-class manufacturer of state-of-the-art compressed air and gas solutions to industry.

Our commitment at nano is to work alongside our **customers** and provide unique solutions with the highest quality products to solve your specific challenges.

A wealth of experience and leading edge products are only part of the equation. nano recognize that world-class customer **service** is the most important component to any successful business.

Experience. Customer. Service... **nano**



clean and dry

Clean and dry compressed air is essential in every efficient and profitable manufacturing and process operation worldwide. nano's vast experience includes food, beverage, chemical, laboratory, medical and natural gas applications.

nano understand your needs and has created the nano range of high-performance, energy-saving compressed air and gas purification products to provide clean and dry compressed air and gases at an affordable price with unrivaled reliability.



design

Our experienced team of design engineers are world leading specialists in the design of new and unique industrial compressed air treatment products and compressed air dryers.



research & development

A core element of our capabilities - founded on cumulative decades of practical engineering expertise - our R&D team is continually looking for improved performance and reliability.



manufacture

Our twin tower desiccant air dryers are built here in North America at a state of the art manufacturing facility to the highest standards of quality which ensure equipment reliability and high levels of performance.



nano D⁵ twin tower air dryers

Ambient air contains high levels of moisture, dust, hydrocarbons and other contaminants. Under pressure these contaminants are concentrated to harmful proportions. When left untreated the results are corrosion, bacteria, mold growth and freezing within your compressed air lines. This contamination causes damage to downstream equipment, leading to increasing maintenance, downtime and product spoilage.

While compressed air filters will remove solid particulate, liquids and aerosols, they cannot remove the moisture that remains in the form of vapor. This vapor will continuously condense into liquid water throughout your compressed air system as the pressure and temperature of the compressed air changes.

The nano D⁵ twin tower desiccant air dryers are designed to remove water vapor, lowering the pressure dew point of your compressed air stream to -40°F or even -100°F. No liquid water or ice crystals will form even if the temperature of the compressed air falls to 40 degrees below zero!

Designed for the most demanding applications, the nano D⁵ twin tower desiccant air dryers are your solution for continuous and uninterrupted clean dry air.

Reliability is built in... and backed by our 5 year warranty on inlet and purge exhaust valves and 3 year heater warranty⁽¹⁾



which dryer is right for you?

In a twin tower desiccant air dryer, one tower is on-line drying the compressed air while the other is off-line regenerating, which means it is eliminating the water vapor it has collected so it can be used to dry again. The two towers switch back and forth so one is always drying while the other is regenerating.

All nano D⁵ twin tower desiccant dryers remove moisture from your compressed air in the same way and to the same exacting standards of performance and reliability. The difference is in how they regenerate and the amount of compressed air and/or power required to do so.

Which dryer to select for a given application is a function of several factors including: initial dryer investment, the cost of operating the dryer and air system capacity. Each of these needs to be considered to ensure the right dryer choice is made.

- **heatless** dryers use expanded dry “purge” air to regenerate the off-line bed. they require the lowest initial investment but require the most purge air⁽²⁾
- **externally heat reactivated** dryers use an electric heater to heat the dry purge air increasing the dryer’s efficiency. they require a higher initial investment although use less purge air than heatless dryers⁽²⁾
- **blower purge** dryers use an electric heater and a blower to provide heated ambient air for regeneration. they require the highest initial investment although can use little to no purge air⁽²⁾

We take pride in our ability to provide you the most cost effective solution for your compressed air treatment needs. Contact support@n-psi.com for help choosing the best D⁵ dryer for your application.

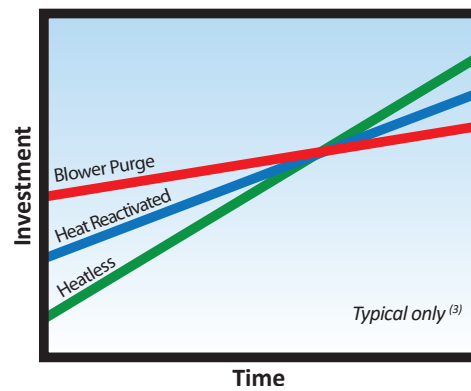

(1) when purchased with recommended pre-filtration

(2) heatless dryers require 15% purge. externally heat reactivated dryers require 8% purge. blower purge dryers require 2% purge (averaged over 4-hour cycle) for dry air cooling, however dry air cooling can be turned off allowing zero air loss operation. values are approximate and are a percentage of the maximum rated inlet flow

(3) results will vary with operating conditions. contact support@n-psi.com to determine which dryer is the most cost effective option for your application

D⁵ heatless desiccant air dryers

The advanced D⁵ NHL heatless desiccant dryer combines reliable field proven components and a cost effective design with 21st century PLC controls and a digital user interface. For clean dry air, there is no better, more dependable, easier to use twin tower dryer available on the market today.

flexible & functional

- field adjustable cycle timing and purge control lets you maximize performance at any operating condition
- advanced PLC controls allow you to monitor the operation of the dryer through an easy to read digital display

unique features

- the purge adjustment valve with visual setting indication allows precision adjustments to the purge flow
- a blend of up to three different desiccants are used in specialty applications to ensure consistent dew point performance

high quality construction

- rugged field proven valves with stainless steel internals and Teflon[®] seats for long life and minimum maintenance
- primed and epoxy coated external surfaces for optimum corrosion protection

cost effective design

- efficient nano pre and after filters combine with high quality desiccant for low pressure drop and consistent dew point performance

customized to meet your needs

- at nano we understand that every customer and every application is different. That is why we provide a wide range of available options to customize your dryer to your specific needs



advanced PLC controls

A powerful programmable logic controller monitors and controls each D⁵ heatless desiccant air dryer. The system monitors multiple inputs, showing pertinent data on the digital display and controlling the fully automated drying and regeneration cycles.

ES Energy Saving Option - The optional "ES" dew point demand system uses a reliable precision hygrometer to continually monitor the outlet dew point and extend the cycle for maximum energy savings. Includes real time outlet dew point indication and high dew point alarm.



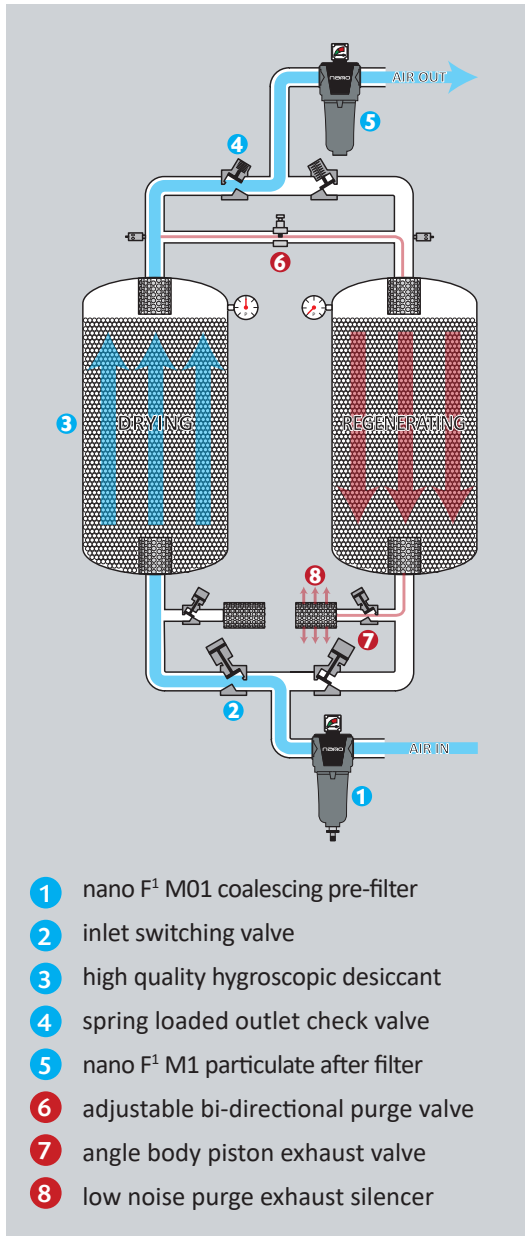

angle body piston valves

- two-way direct acting piston valves with stainless steel internals and Teflon® seats ensure reliable field proven performance
- used for inlet valves on the NHL 200 to 600 and purge exhaust valves for all models



high performance butterfly valves

- pneumatic actuators ensure precise proportional control and a bubble tight seal
- rugged stainless steel disk construction and Teflon® seats combined with a low pressure drop design
- used for inlet valves on the NHL 800 and larger



stainless steel check valves

- stainless steel spring return check valves provide worry-free operation and minimal maintenance
- lift style check valves used on the NHL 200 to 600 and wafer style check valves used on the NHL 800 and larger

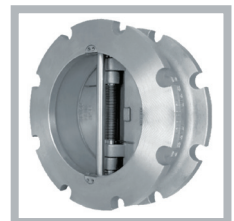

precision purge control valve

- purge flow is field adjustable with this precision valve with visual setting indication
- allows the operator to easily adjust the purge flow to match the operating conditions for optimal energy savings



low noise exhaust mufflers

- these specially designed exhaust mufflers minimize the noise of depressurization and purge exhaust while also minimizing back pressure
- the high flow design reduces blockage extending service life

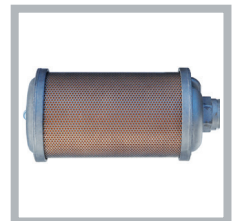

options & upgrades

option	description	changes	from	to	benefit
ES	Energy Saving	regeneration cycle	timed operation	dew point dependent operation	significant purge & energy savings
3V	3 Valve Bypass	ability to bypass unit	none	manual 3 valve block & bypass	maintenance without stopping air flow
LDP	Low Dew Point	outlet pressure dew point	-40°F (ISO 12500 Class 2)	-100°F (ISO 12500 Class 1)	improves downstream air quality
N4	NEMA 4	electrical protection	NEMA 12	NEMA 4	greater protection against contamination
N4X	NEMA 4X	electrical protection	NEMA 12	NEMA 4X	as above, plus greater corrosion resistance
N7	NEMA 7	electrical protection	NEMA 12	NEMA 7	for explosion proof environments
50HZ	50Hz Power	inlet power supply	120 VAC / 1 Ph / 60 Hz	220 VAC / 1 Ph / 50 Hz	allows 50Hz power supply
PC	Pneumatic Controls	inlet power supply	120 VAC / 1 Ph / 60 Hz	fully pneumatic	eliminates power supply
HP	High Pressure	allowable working pressure	50 to 150 psig	50 to 250 psig	allows higher inlet pressures
LA	Low Ambient	allowable working temp	34 to 120°F	-15°F to 120°F	allows lower ambient temperatures

list is not all inclusive. contact support@n-psi.com for a complete list of available options

NHL sizing & specifications

dryer model	inlet & outlet		rated flow ⁽²⁾		dimensions (inches)			approx. weight	recommended filtration ⁽³⁾	
	NPT(F)/FLG ⁽¹⁾	scfm	Nm ³ /h	A	B	C	lbs	pre filter	after filter	
NHL 200	1"	200	340	34	85	24	650	NF 0290 M01	NF 0290 M1	
NHL 250	1 ½"	250	425	39	86	24	810	NF 0290 M01	NF 0290 M1	
NHL 300	1 ½"	300	510	39	86	24	830	NF 0325 M01	NF 0325 M1	
NHL 400	2"	400	680	44	87	26	1020	NF 0450 M01	NF 0450 M1	
NHL 500	2"	500	850	47	88	26	1210	NF 0700 M01	NF 0700 M1	
NHL 600	2"	600	1020	47	88	26	1230	NF 0700 M01	NF 0700 M1	
NHL 800	3"	800	1360	66	97	40	2400	NF 1000 M01	NF 1000 M1	
NHL 1000	3"	1000	1700	66	97	40	2350	NF 1000 M01	NF 1000 M1	
NHL 1250	3"	1250	2125	66	97	40	2560	NF 1250 M01	NF 1250 M1	
NHL 1500	3"	1500	2550	66	97	40	3250	NF 1500 M01	NF 1500 M1	
NHL 2000	4"	2000	3400	84	115	59	3600	NFZ 2500 M01	NFZ 2500 M1	
NHL 2500	4"	2500	4250	84	115	60	4100	NFZ 2500 M01	NFZ 2500 M1	
NHL 3000	6"	3000	5100	103	137	70	6000	NFZ 3500 M01	NFZ 3500 M1	
NHL 3500	6"	3500	5945	103	137	70	6800	NFZ 3500 M01	NFZ 3500 M1	
NHL 4000	6"	4000	6795	103	137	70	7300	NFZ 4000 M01	NFZ 4000 M1	
NHL 4500	6"	4500	7645	120	130	70	7500	NFZ 5000 M01	NFZ 5000 M1	
NHL 5000	6"	5000	8495	120	130	70	8200	NFZ 5000 M01	NFZ 5000 M1	

specifications	standard	optional
maximum particle size (ISO class) ⁽⁶⁾	class 2 (1 micron)	class 1 (0.01 micron)
maximum water content (ISO class) ⁽⁶⁾	class 2 (-40°F pdp)	class 1 (-94°F pdp)
design operating pressure range	80 to 150 psig ⁽⁸⁾	50 to 250 psig
recommended operating temp range	38 to 120°F	-
design operating temperature range	35 to 120°F	-
power supply requirements	115V/1Ph/60Hz	220V/1Ph/50Hz & 230V/1Ph/60Hz

pressure correction factors ⁽⁷⁾									
inlet air pressure (psig)	60	70	80	90	100	110	130	140	150
correction factor	0.65	0.74	0.83	0.91	1	1.04	1.12	1.16	1.20

temperature correction factors ⁽⁷⁾								
inlet air temperature (°F)	70	80	90	100	105	110	115	120
correction factor	1.12	1.10	1.06	1	0.93	0.86	0.80	0.75

- (1) 2" and below are NPT(F) threaded. 3" and above are flanged. All units with 3" piping will be ANSI welded pipe and the filter connections will be flanged
- (2) at an inlet conditions of 100 psig and 100°F. For all other inlet conditions refer to the correction factors above
- (3) recommended for all applications
- (4) includes pre and after filters mounted on the dryer
- (5) approximate weight for models NHL 2000 to 5000 does not include desiccant installed
- (6) per ISO 8573.1:2010
- (7) to be used as a rough guide only. All applications should be confirmed by nano. Contact support@n-psi.com
- (8) NHL 2000 and up maximum working pressure is 125 psig
- (9) units are certified UL/CuL
- (10) NHL 200 - NHL 2500 have ASME & CRN coded pressure vessels; NHL 3000 and up have ASME coded pressure vessels
- (11) specifications subject to change without notice

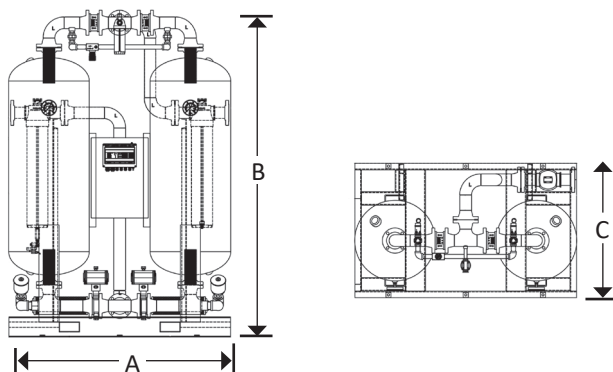

D⁵ externally heated

The D⁵ NEX externally heat reactivated dryers use heat to reduce the use of costly purge air. For consistent performance and cost effective operation these dryers are your optimum choice.

flexible & functional

- advanced PLC controls allow you to monitor the operation of the dryer through an easy to use digital display
- multiple thermocouples control regeneration and provide constant temperature

unique features

- secondary heater contactor provides protection against overheating in the event of a primary contactor failure
- visual alarm lights and step by step diagnostics simplify troubleshooting

high quality construction

- rugged field proven digitally controlled dual acting high performance butterfly valves and stainless steel spring return wafer check valves ensure long operating life and minimum maintenance
- insulated external electric heaters for efficient regeneration in all operating conditions

cost effective design

- nano M01 coalescing pre filters and NHT M1 high temperature after filters with high quality hygroscopic desiccant ensure low pressure drop and consistent dew point performance

customized to meet your needs

- at nano we understand that every customer and every application is different. That is why we provide a wide range of available options to customize your dryer to your specific needs



advanced PLC controls

The new Siemens S7-1200 PLC dryer controller with color touch screen display (HMI) provides the flexibility and power to control the heated type dryers and in support of your automation needs. The compact design, flexible configuration, and powerful instruction set combine to make the S7-1200 a perfect solution for controlling dryers.

The CPU combines a microprocessor, an integrated power supply, input and output circuits, built-in PROFINET, high-speed motion control I/O, and on-board analog inputs. The CPU contains the logic required to monitor and control the dryers function. The CPU provides a PROFINET port for communication over a PROFINET network. Additional modules are available for communicating over PROFIBUS, GPRS, RS485 or RS232 networks.

ES Energy Saving Option - The optional "ES" dew point demand system uses a reliable precision hygrometer to continually monitor the outlet dew point and adjust the cycle for maximum energy savings. Includes real time outlet dew point indication and an adjustable high dew point alarm.



standard features

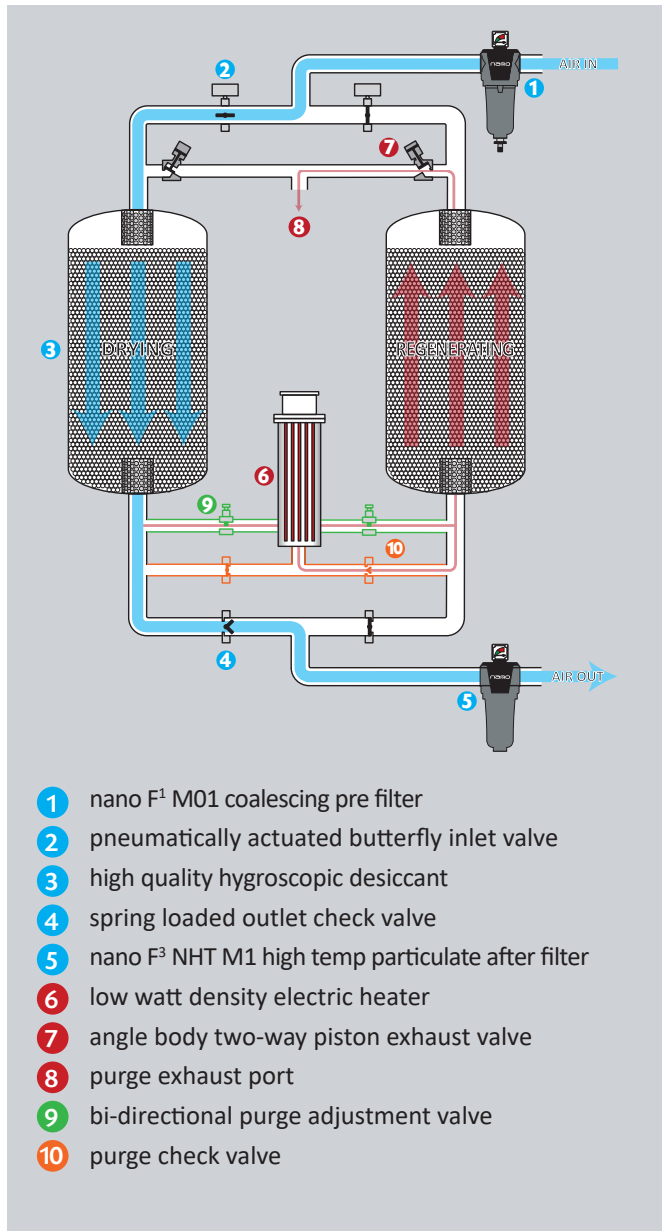

- 1 nano F¹ M01 coalescing pre filter
- 2 pneumatically actuated butterfly inlet valve
- 3 high quality hygroscopic desiccant
- 4 spring loaded outlet check valve
- 5 nano F³ NHT M1 high temp particulate after filter
- 6 low watt density electric heater
- 7 angle body two-way piston exhaust valve
- 8 purge exhaust port
- 9 bi-directional purge adjustment valve
- 10 purge check valve

low watt density heater

- regeneration circuit is fully insulated for maximum efficiency
- specifically designed for a long and dependable operating life in harsh industrial environments



stainless steel check valves

- metal on metal seats for reliable high temperature operation
- dependable stainless steel spring return check valves provide worry-free operation and minimal maintenance

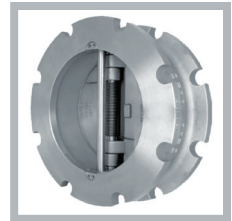

high performance butterfly valves

- pneumatic actuators ensure precise proportional control and a bubble tight seal
- stainless steel and Teflon® seats in a reliable and low pressure drop design



precision purge control valve

- purge flow is field adjustable with this precision valve with visual setting indication
- easily adjust the purge flow to match the operating conditions



HMI interface

- synoptic display with visual dryer operation
- alarm indication and description

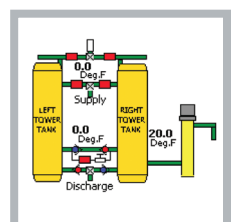

options & upgrades

option	description	changes	from	to	benefit
ES	Energy Saving	regeneration cycle	timed operation	dew point dependent operation	significant purge & energy savings
3V	3 Valve Bypass	ability to bypass unit	none	manual 3 valve block & bypass	maintenance without stopping air flow
TI	Tower Insulation	thermal insulation	heater & regen piping only	heater, towers & heated piping	reduces ambient heat loss
N4	NEMA 4	electrical protection	NEMA 12	NEMA 4	greater protection against contamination
N4X	NEMA 4X	electrical protection	NEMA 12	NEMA 4X	as above, plus greater corrosion resistance
N7	NEMA 7	electrical protection	NEMA 12	NEMA 7	for explosion proof environments
575V	575 Volt Power	inlet power supply	460 VAC / 3 Ph / 60 Hz	575 VAC / 3 Ph / 60 Hz	allows 575V power supply
50HZ	50Hz Power	inlet power supply	460 VAC / 3 Ph / 60 Hz	380 VAC / 3 Ph / 50 Hz	allows 50Hz power supply
HP	High Pressure	allowable working pressure	50 to 150 psig	50 to 250 psig	allows higher inlet pressures
LA	Low Ambient	allowable working temp	34 to 120°F	-15°F to 120°F	allows lower ambient temperatures

list is not all inclusive. contact support@n-psi.com for a complete list of available options

NEX sizing & specifications

dryer model	inlet & outlet		rated flow ⁽²⁾		dimensions (inches)			approx. weight	recommended filtration ⁽³⁾	
	NPT(F)/FLG ⁽¹⁾	scfm	Nm ³ /h	A	B	C	lbs	pre filter	after filter	
NEX 200	1"	200	340	34	92	35	650	NF 0290 M01	NHT 0300 M1	
NEX 250	1 ½"	250	425	36	92	34	850	NF 0290 M01	NHT 0300 M1	
NEX 300	1 ½"	300	510	36	92	34	1140	NF 0325 M01	NHT 0300 M1	
NEX 400	2"	400	680	47	92	45	1300	NF 0450 M01	NHT 0450 M1	
NEX 500	2"	500	850	47	92	45	1400	NF 0700 M01	NHT 0650 M1	
NEX 600	2"	600	1020	47	92	45	1500	NF 0700 M01	NHT 0650 M1	
NEX 800	3"	800	1360	70	96	50	3450	NF 0850 M01	NHT 1000 M1	
NEX 900	3"	900	1530	70	96	50	4050	NF 1000 M01	NHT 1000 M1	
NEX 1000	3"	1000	1700	70	96	50	4250	NF 1000 M01	NHT 1000 M1	
NEX 1250	3"	1250	2125	69	97	60	4550	NF 1250 M01	NHT 1250 M1	
NEX 1500	3"	1500	2550	69	97	60	5150	NF 1500 M01	NHT 1600 M1	
NEX 2000	4"	2000	3400	85	113	68	8900	NFZ 2500 M01	NFZ 2500 M1HT	
NEX 2500	4"	2500	4250	85	113	68	9150	NFZ 2500 M01	NFZ 2500 M1HT	
NEX 3000	6"	3000	5100	125	133	82	11050	NFZ 3500 M01	NFZ 3500 M1HT	
NEX 3500	6"	3500	5950	125	133	82	11550	NFZ 3500 M01	NFZ 3500 M1HT	

specifications	standard	optional
maximum particle size (ISO class) ⁽⁶⁾	class 2 (1 micron)	class 1 (0.01 micron)
maximum water content (ISO class) ⁽⁶⁾	class 2 (-40°F pdp)	-
design operating pressure range	80 to 150 psig	58 to 250 psig
recommended operating temp range	40 to 100°F	-
design operating temperature range	35 to 120°F	-
power supply requirements	460 VAC / 60 Hz	575 V / 60 Hz or 380 VAC / 50 Hz

pressure correction factors ⁽⁷⁾										
inlet air pressure (psig)	60	70	80	90	100	110	130	140	150	
correction factor	0.65	0.74	0.83	0.91	1	1.04	1.12	1.16	1.20	

temperature correction factors ⁽⁷⁾									
inlet air temperature (°F)	70	80	90	100	105	110	115	120	
correction factor	1.12	1.10	1.06	1	0.93	0.86	0.80	0.75	

- (1) 2" and below are NPT(F) threaded. 3" and above are flanged. All units with 3" piping will be ANSI welded pipe and the filter connections will be flanged
- (2) at an inlet conditions of 100 psig and 100°F. For all other inlet conditions refer to the correction factors above
- (3) recommended for all applications
- (4) includes pre and after filters mounted on the dryer
- (5) approximate weight for models NEX 2000 to 3500 does not include desiccant installed
- (6) per ISO 8573.1:2010
- (7) to be used as a rough guide only. All applications should be confirmed by nano. Contact support@n-psi.com
- (8) units are UL/CUL certified
- (9) units have ASME & CRN coded pressure vessels
- (10) specifications subject to change without notice

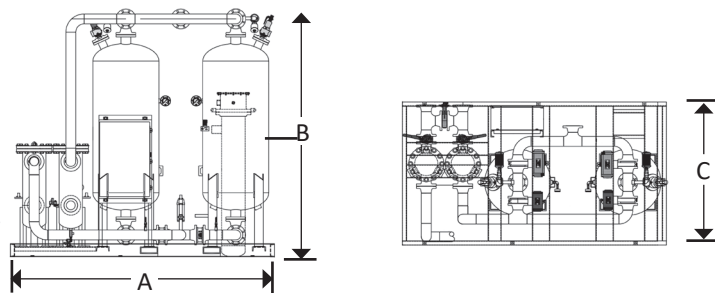

D⁵ blower purge

The D⁵ NEX externally heat reactivated dryers use heat to reduce the use of costly purge air. The NBP blower purge dryers take it a step further using a combination of heat and ambient air to further reduce (or even eliminate) purge air usage. For consistent performance and cost effective operation these dryers are your optimum choice.

flexible & functional

- advanced PLC controls allow you to monitor the operation of the dryer through an easy to use digital display
- multiple thermocouples control regeneration and provide constant temperature display

unique features

- secondary heater contactor provides protection against overheating in the event of a primary contactor failure
- visual alarm lights and step by step diagnostics simplify troubleshooting
- selectable “Dry Air Cooling” mode lets you choose between maximum performance and maximum energy savings depending on the needs of your application

high quality construction

- rugged field proven digitally controlled dual acting high performance butterfly valves and stainless steel spring return wafer check valves ensure long operating life and minimum maintenance
- insulated external electric heaters and high efficiency regenerative blowers for efficient regeneration in all operating conditions

cost effective design

- nano M01 coalescing pre filters and NHT M1 high temperature after filters with high quality hygroscopic desiccant ensure low pressure drop and consistent dew point performance

customized to meet your needs

- at nano we understand that every customer and every application is different. that is why we provide a wide range of available options to customize your dryer to your specific needs



advanced PLC controls

The new Siemens S7-1200 PLC dryer controller with color touch screen display (HMI) provides the flexibility and power to control the heated type dryers and in support of your automation needs. The compact design, flexible configuration, and powerful instruction set combine to make the S7-1200 a perfect solution for controlling dryers.

The CPU combines a microprocessor, an integrated power supply, input and output circuits, built-in PROFINET, high-speed motion control I/O, and on-board analog inputs. The CPU contains the logic required to monitor and control the dryers function. The CPU provides a PROFINET port for communication over a PROFINET network. Additional modules are available for communicating over PROFIBUS, GPRS, RS485 or RS232 networks.

ES Energy Saving Option - The optional “ES” dew point demand system uses a reliable precision hygrometer to continually monitor the outlet dew point and adjust the cycle for maximum energy savings. Includes real time outlet dew point indication and an adjustable high dew point alarm.



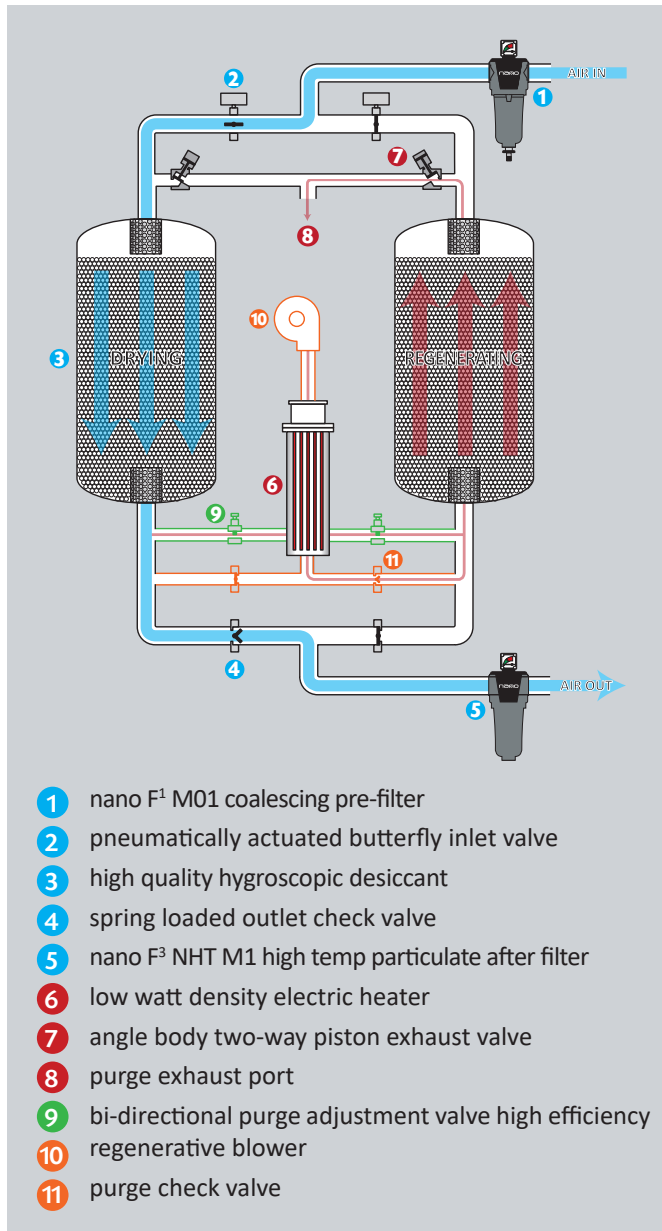

efficient regenerative blower

- field proven high efficiency blower combines reliable performance and a long operating life
- regenerative design for lower noise levels than typical blowers



low watt density heater

- regeneration circuit is fully insulated for maximum efficiency
- specifically designed for a long and dependable operating life in harsh industrial environments



stainless steel check valves

- metal on metal seats for reliable high temperature operation
- dependable stainless steel spring return check valves provide worry-free operation and minimal maintenance

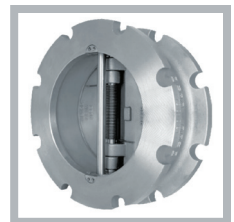

high performance butterfly valves

- pneumatic actuators ensure precise proportional control and a bubble tight seal
- stainless steel and Teflon® seats in a reliable and low pressure drop design



precision purge control valve

- purge flow is field adjustable with this precision valve with visual setting indication
- easily adjust the purge flow to match the operating conditions



options & upgrades

option	description	changes	from	to	benefit
ES	Energy Saving	regeneration cycle	timed operation	dew point dependent operation	significant purge & energy savings
3V	3 Valve Bypass	ability to bypass unit	none	manual 3 valve block & bypass	maintenance without stopping air flow
LDP	Low Dew Point	outlet pressure dew point	-40°F (ISO 12500 Class 2)	-65°F (ISO 12500 Class 2)	improves downstream air quality
TI	Tower Insulation	thermal insulation	heater & regen piping only	heater, towers & heated piping	reduces ambient heat loss
N4	NEMA 4	electrical protection	NEMA 12	NEMA 4	greater protection against contamination
N4X	NEMA 4X	electrical protection	NEMA 12	NEMA 4X	as above, plus greater corrosion resistance
N7	NEMA 7	electrical protection	NEMA 12	NEMA 7	for explosion proof environments
575V	575 Volt Power	inlet power supply	460 VAC / 3 Ph / 60 Hz	575 VAC / 3 Ph / 60 Hz	allows 575V power supply
50HZ	50Hz Power	inlet power supply	460 VAC / 3 Ph / 60 Hz	380 VAC / 3 Ph / 50 Hz	allows 50Hz power supply
HP	High Pressure	allowable working pressure	50 to 150 psig	50 to 250 psig	allows higher inlet pressures
LA	Low Ambient	allowable working temp	34 to 120°F	-15°F to 120°F	allows lower ambient temperatures

list is not all inclusive. contact support@n-psi.com for a complete list of available options

NBP sizing & specifications

dryer model	inlet & outlet		rated flow ⁽²⁾		dimensions (inches)			approx. weight	recommended filtration ⁽³⁾	
	NPT(F)/FLG ⁽⁴⁾	scfm	Nm ³ /h	A	B	C	lbs	pre filter	after filter	
NBP 500	2"	500	850	71	94	44	1800	NF 0700 M01	NHT 0650 M1	
NBP 650	2"	650	1105	71	94	44	1900	NF 0700 M01	NHT 0650 M1	
NBP 800	3"	800	1360	93	95	60	5100	NF 1000 M01	NHT 1000 M1	
NBP 1000	3"	1000	1700	93	95	60	5500	NF 1000 M01	NHT 1000 M1	
NBP 1250	3"	1250	2125	93	95	60	6000	NF 1250 M01	NHT 1250 M1	
NBP 1500	3"	1500	2550	93	95	60	6400	NF 1500 M01	NHT 1600 M1	
NBP 2000	3"	2000	3400	140	113	65	7700	NFZ 2500 M01	NFZ 2500 M1HT	
NBP 2500	4"	2500	4250	140	113	65	8300	NFZ 2500 M01	NFZ 2500 M1HT	
NBP 3000	6"	3000	5100	156	115	71	10700	NFZ 3500 M01	NFZ 3500 M1HT	
NBP 3500	6"	3500	5950	156	134	71	11500	NFZ 3500 M01	NFZ 3500 M1HT	
NBP 4000	6"	4000	6800	156	134	71	12600	NFZ 4000 M01	NFZ 4000 M1HT	
NBP 5000	6"	5000	8500	167	134	87	13600	NFZ 5000 M01	NFZ 5000 M1HT	
NBP 6000	6"	6000	10200	167	134	87	15000	NFZ 6000 M01	NFZ 6000 M1HT	
NBP 7000	8"	7000	11890	175	134	87	16000	NFZ 7500 M01	NFZ 7500 M1HT	
NBP 8000	8"	8000	13590	200	144	88	17000	NFZ 8500 M01	NFZ 8500 M1HT	
NBP 9000	10"	9000	15290	218	152	88	18000	NFZ 10000 M01	NFZ10000 M1HT	
NBP 10000	10"	10000	16990	218	152	88	19000	NFZ 10000 M01	NFZ 10000 M1HT	

specifications	standard	optional
maximum particle size (ISO class) ⁽⁶⁾	class 2 (1 micron)	class 1 (0.01 micron)
maximum water content (ISO class) ⁽⁶⁾	class 2 (-40°F pdp)	-
design operating pressure range	80 to 150 psig	58 to 250 psig
recommended operating temp range	40 to 100°F	-
design operating temperature range	35 to 120°F	-
power supply requirements	460 VAC / 60 Hz	575V / 60 Hz or 380 VAC / 50 Hz

pressure correction factors ⁽⁷⁾									
inlet air pressure (psig)	60	70	80	90	100	110	130	140	150
correction factor	0.65	0.74	0.83	0.91	1	1.04	1.12	1.16	1.20

temperature correction factors ⁽⁷⁾								
inlet air temperature (°F)	70	80	90	100	105	110	115	120
correction factor	1.12	1.10	1.06	1	0.93	0.86	0.80	0.75

- (1) 2" and below are NPT(F) threaded. 3" and above are flanged. All units with 3" piping will be ANSI welded pipe and the filter connections will be flanged
- (2) at an inlet of 100 psig and 100°F. For all other inlet conditions refer to the correction factors above
- (3) recommended for all applications
- (4) includes pre and after filters mounted on the dryer through Model NBP 5000. Skid mounted pre and after filters for Models NBP 6000 to NBP 10000
- (5) approximate weight for models NBP 2000 to 10000 does not include desiccant installed
- (6) per ISO 8573.1:2010
- (7) to be used as a rough guide only. Confirm sizing with nano. Contact support@n-psi.com
- (8) units are UL/CuL certified
- (9) units have ASME & CRN coded pressure vessels
- (10) specifications subject to change without notice

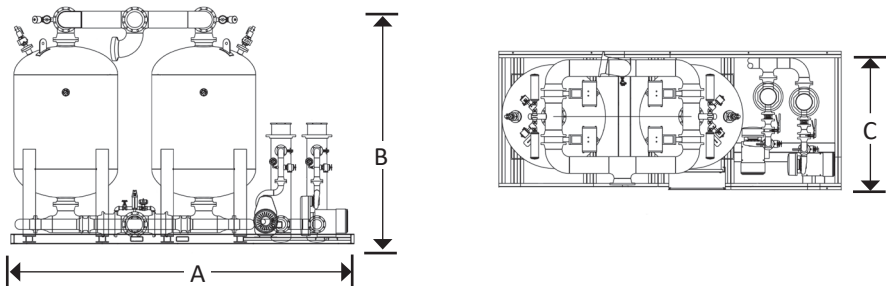

<p>nano-purification solutions llc charlotte, north carolina united states</p> <p>tel: 704.897.2182 • fax: 704.897.2183 • support@n-psi.com • www.n-psi.com</p>	<p>nano-purification solutions ltd gateshead, tyne and wear united kingdom</p>	<p>nano-purification solutions st. catharines, ontario canada</p>
--	---	--



1 YEAR WARRANTY

nano
PURIFICATION SOLUTIONS

copyright PURIFICATION SOLUTIONS LLC
publication reference n-psi-D5-06-us