



nano F¹: Compressed Air & Gas Filtration

GMS 0900

900 scfm Medical Sterile Filter

nano GMS medical sterile filters are specifically designed and manufactured to exceed the requirements for medical gas pipeline systems providing reliable and outstanding air purity that meets internationally certified medical performance levels. Applications include: dental, medical and veterinary.

GENERAL CHARACTERISTICS	
Rated flow (scfm) ⁽¹⁾	900
OPERATING LIMITS	
Design operating pressure range (psig)	22 to 300
Design operating temperature range (°F)	35 to 248
HOUSING CONSTRUCTION	
Materials	pressure die cast aluminum
Finish	E-Coat™ surface treatment (internal & external) powder paint (external)
ELEMENT CONSTRUCTION	
Media	borosilicate glass microfiber
End caps	stainless steel
Replacement element (part no.)	GE 0900MS
COMPONENTS	
Manual drain (part no.)	GFMDK 1500
Differential pressure indicator / gauge	gauge
DP (part no.)	GFDP 1500
AIR CIRCUIT	
Air circuit connections (NPT)	3"

(1) At 100 psig. For all other pressures, contact support@nano-purification.com.

Features

HOUSING FEATURES

- Designed in accordance with ASME pressure vessel standards.
- Carries CRN (Canadian Registration Numbers) for approved use in every province of Canada.
- "Dead Stop" bowl feature provides full closure without over tightening.
- 10 year housing warranty
- Optimized seal ensures zero leakage and ease of bowl removal during element replacement.
- No tie rod simplifies element change out and reduces access requirements for bowl removal.
- Comprehensive range of filter mounting accessories

ELEMENT FEATURES

- Third party tested and validated in accordance with NFPA 99, HTM 02-01, ISO 7396-1, and AS 2896.
- 100% integrity tested
- Guaranteed for a minimum of 100 sterilizations at 248°F.
- Stainless steel end caps for compatibility with autoclave sterilization.



Dimensions & Weight

DIMENSIONS AND WEIGHT	
A (ins)	8.66
B (ins)	2.76
C (ins) *	28.98
D (ins)	1.18
E (ins)	33.4
Weight (lbs)	23.1

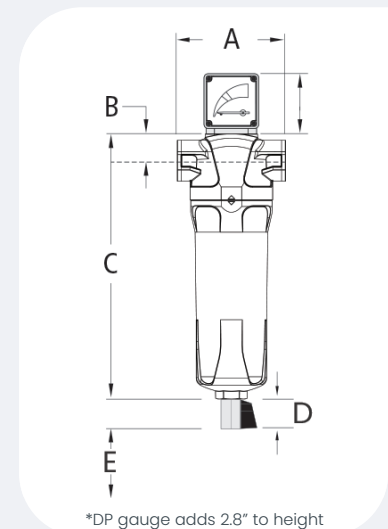

nano F1.1: Medical Sterile Filters

ELEMENT GRADES	MS
DOP efficiency ⁽¹⁾	> 99.9999%
Particle removal (microns) ⁽²⁾	0.01
Recommended operating temperature range (°F)	35 to 212
Design operating temperature range (°F)	35 to 248
Maximum autoclave temperature ⁽³⁾	273
Pressure drop - clean (psid)	1.5
Pressure drop - recommended replacement (psid)	6.0
End cap material	stainless steel
Flow direction through element	outside to inside
Maximum steam sterilization cycle	100
Maximum element life	6 months or 1000 hours

(1) As specified in HTM 02-01 medical gas pipeline systems.

(2) Per ISO 8573.1:2010

(3) Applies to element only.

Accessories

CONNECTING KITS	FITS	PART NUMBER
Connecting kit (2 Filters)	GMS 0900	GFCK-2 1500



WALL MOUNTING KITS	FITS	PART NUMBER
Wall mounting kit	GMS 0900	GFMK 1500



Technical specifications subject to change without notice.
 Publication Reference: GMS0900-US-EN-Version-000
 ©2024 Air & Gas Solutions LLC



nano
 Experience. Customer. Service.

nano-purification solutions
www.nano-purification.com

United States
 Charlotte, North Carolina
 Phone: +1 704 897 2182
 Email: support@nano-purification.com

United States | Canada | United Kingdom | Germany | Singapore