



nano F¹: Compressed Air & Gas Filtration

GMSB 0105

179 Nm³/h Medical Sterile Filter

nano GMSB medical sterile filters are specifically designed and manufactured to exceed the requirements for medical gas pipeline systems providing reliable and outstanding air purity that meets internationally certified medical performance levels. Applications include: dental, medical and veterinary.

GENERAL CHARACTERISTICS	
Rated flow (Nm ³ /h) ⁽¹⁾	179
OPERATING LIMITS	
Design operating pressure range (barg)	1.5 to 20.7
Design operating temperature range (°C)	1.7 - 120
HOUSING CONSTRUCTION	
Materials	pressure die cast aluminium
Finish	E-Coat™ surface treatment (internal & external) powder paint (external)
ELEMENT CONSTRUCTION	
Media	borosilicate glass microfiber
End caps	stainless steel
Replacement element (part no.)	GE 0105MS
COMPONENTS	
Manual drain	GFMDKB 1500
Differential pressure indicator / gauge	guage
DP (part no.)	GFDP 1500
AIR CIRCUIT	
Air circuit connections (BSPP)	1"

(1) At 7 barg. For all other pressures, refer to the pressure correction factor table above.

Features

HOUSING FEATURES

- Designed in accordance with ASME pressure vessel standards.
- Carries CRN (Canadian Registration Numbers) for approved use in every province of Canada.
- "Dead Stop" bowl feature provides full closure without over tightening.
- 10 year housing warranty
- Optimised seal ensures zero leakage and ease of bowl removal during element replacement.
- No tie rod simplifies element change out and reduces access requirements for bowl removal.
- Comprehensive range of filter mounting accessories

ELEMENT FEATURES

- Third party tested and validated in accordance with NFPA 99, HTM 02-01, ISO 7396-1, and AS 2896.
- 100% integrity tested
- MS elements rated for a minimum of 100 sterilisations at 120°C.
- Includes element with stainless steel end caps for compatibility with autoclave sterilisation.



Dimensions & Weight

DIMENSIONS AND WEIGHT	
A (mm)	127
B (mm)	32
C (mm)	285
D (mm)	30
E (mm)	396
Weight (kg)	1.68

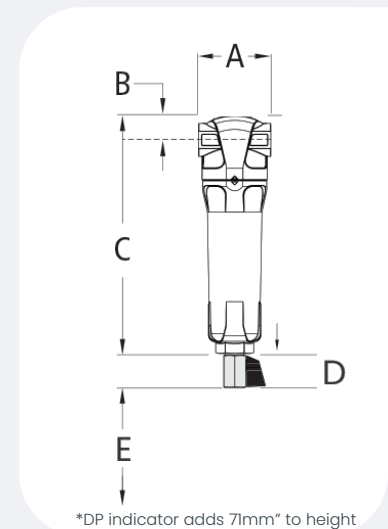

nano F^{1.1}: Medical Sterile Filters

ELEMENT GRADES	MS
DOP efficiency ⁽³⁾	> 99.9999%
Particle removal (micron)	0.01
Recommended operating temperature range (°C)	2 to 100
Design operating temperature range (°C)	2 to 120
Maximum autoclave temperature °C ⁽⁴⁾	134
Pressure drop - clean (mbar)	100
Pressure drop - recommended replacement (mbar)	415
End cap material	stainless steel
Flow direction through element	outside to inside
Maximum steam sterilisation cycle	100
Maximum element life	6 months or 1000 hours

(1) As specified in HTM 02-01 medical gas pipeline systems.

(2) Per ISO 8573.1:2010.

(3) Applies to element only.

Accessories

CONNECTING KITS	FITS	PART NUMBER
Connecting kit (2 Filters)	GMSB 0105	GFCK-2 0175



WALL MOUNTING KITS	FITS	PART NUMBER
Wall mounting kit	GMSB 0105	GFMK 0175



Technical specifications subject to change without notice.
 Publication Reference: GMSB0105-UK-EN-Version-000
 ©2024 Air & Gas Solutions LLC

nano
 Experience. Customer. Service.

nano-purification solutions
www.nano-purification.com

United Kingdom
 Gateshead, United Kingdom
 Phone: +44 (0) 191 497 7700
 Email: sales_uk@nano-purification.com

United States | Canada | United Kingdom | Germany | Singapore