

DHM 0040 55F

40.3 scfm membrane air dryer

The nano M¹ membrane compressed air dryer provides clean dry air for a wide range of industrial applications. Designed for minimal pressure drop and the highest drying efficiency, the dryers contain thousands of hollow fibers with a unique inner coating. As the wet compressed air enters the dryer, the membrane coating causes water vapor to permeate and collect between the fibers, while the clean, dry air continues through the dryer to its application.



general characteristics	
rated flow (scfm) ⁽¹⁾	40.3
purge air consumption (%)	14
pressure drop over dryer (psi) ⁽²⁾	2.5
pressure suppression dew point ⁽³⁾	57.6
operating limits	
design operating pressure range (psig)	58 to 203
design operating temperature range (°F)	33.8 to 150.8
minimum/maximum ambient temperature (°F)	33.8 to 150.8
maximum inlet temperature (°F)	150.8
standard pre-filtration	
prefilter part nos	NF 0050 M1/ NF 0050 M01
air circuit	
air circuit connections (NPT)	½"

(1) rated flow capacity: compressed air dryer inlet: 101.5 psig and 95°F; ambient air temperature: 77°F; 100% RH. For all other conditions, contact support@n-psi.com

(2) pressure drop does not include inlet pre-filters

(3) with respect to pressure dew point at the inlet to the membrane dryer

features

- 1 micron and 0.01 micron pre-filters with all interconnecting components included as standard
- flexible end cap configuration allows for horizontal or vertical installation
- multiple purge nozzles included for optimizing performance at higher pressures (101.5 installed / 145 / 188.8 psig)
- requires no electricity for operation
- broad operating range allows for operation in widely fluctuating temperatures
- suitable for use in systems with high vibration
- quiet operation allows for installation at point of use
- unique membrane coating increases the separation efficiency producing the lowest purge air loss

nano-purification solutions
charlotte, north carolina
united states

nano-purification solutions
new bethlehem, pennsylvania
united states

nano-purification solutions
st. catharines, ontario
canada

nano-purification solutions
gateshead, tyne and wear
united kingdom

nano-purification solutions
erkelenz, germany

tel: 704.897.2182
fax: 704.897.2183
email: support@n-psi.com
web: www.n-psi.com

technical specification

dimensions and weights	horizontal	vertical
A (in)	35.7	35.8
B (in)	14.3	14.3
C (in)	7.9	7.9
D (in)	14.3	11.2
weight (lbs)	11.7	11.7

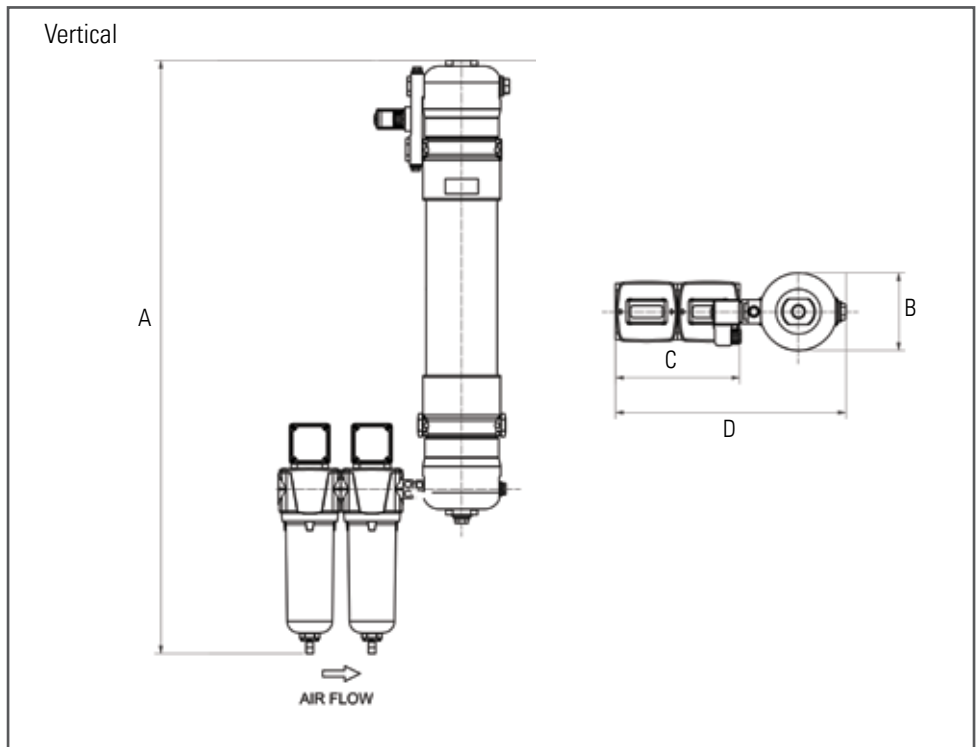
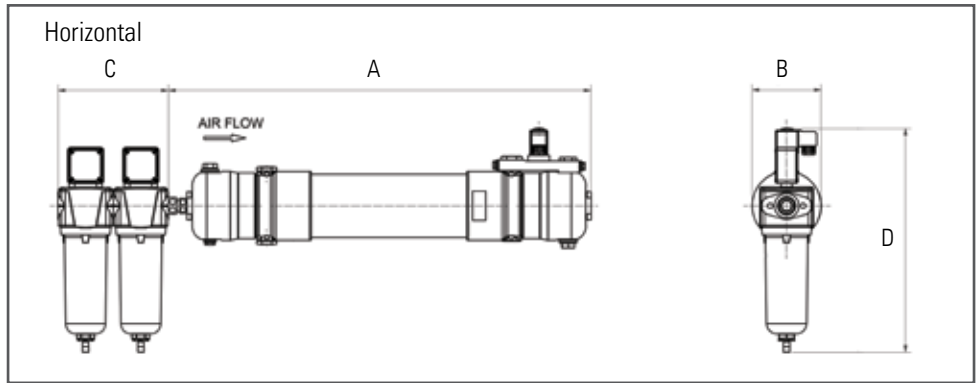

experience