

ELECTRICAL SUPPLY
230V/1F/60HZ

ELECTRICAL SUPPLY
STEADY STATE VOLTAGE : +/- 10%
FREQUENCY : +/- 1%
VOLTAGE UNBALANCE < 2%

COMPRESSOR MOTOR

FAN MOTOR

PUMP MOTOR

B	RES.CARTER	19/07/2016	UFFICIO TECNICO	
A	EMISSIONE	28/06/2016	DATA	28/06/2016
P			DISEGN.	
MOD.	MODIFICHE	DATA	NOME	VISTO

DESCRIZIONE

 PURIFICATION SOLUTIONS
NC 6 US WIRING DIAGRAM



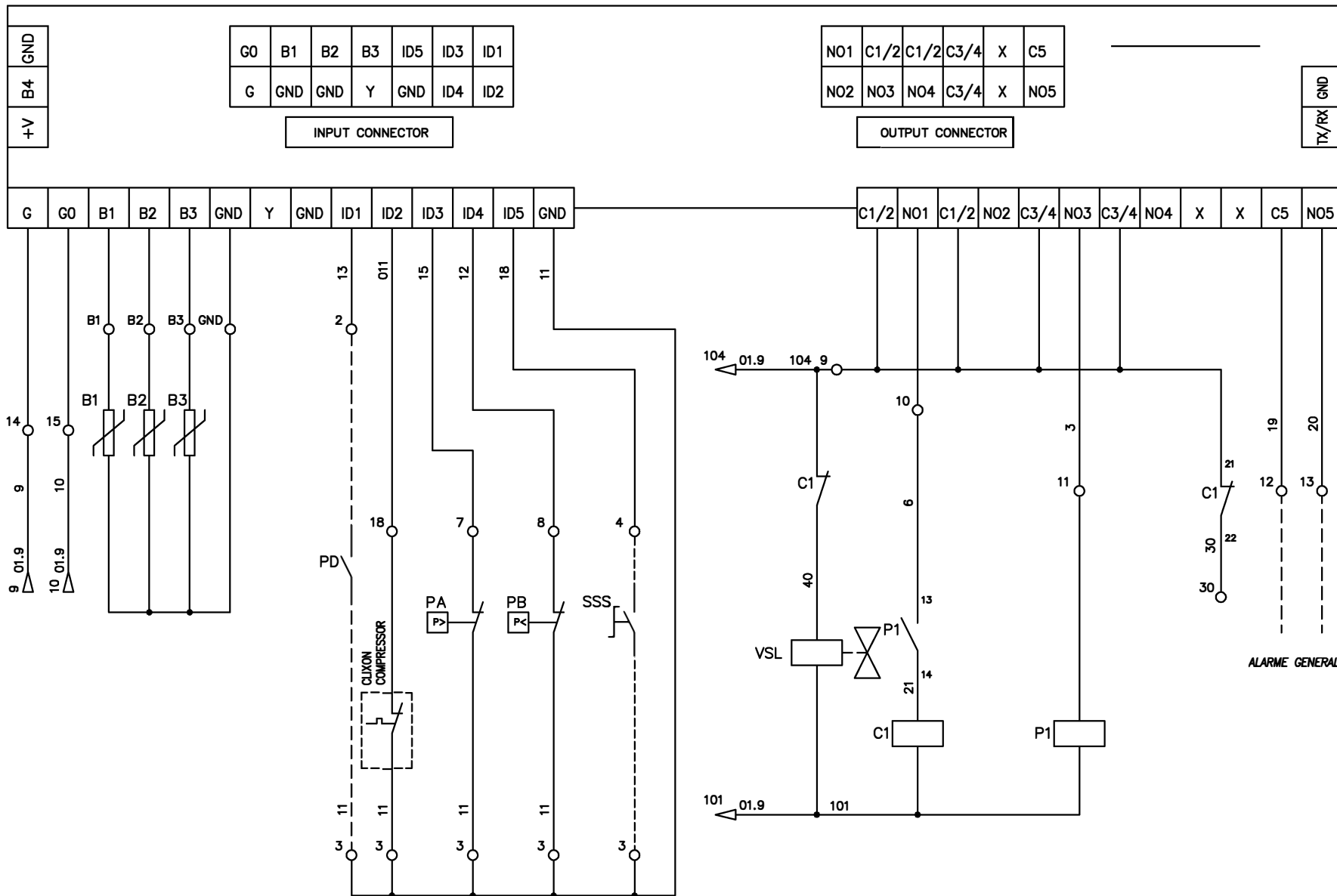



DISEGNO N°	85504105/013/B	FG. N°	DI
		001	003



COMPONENTS DESCRIPTION

IN	— GENERAL MAIN SWITCH
Q1	— COMPRESSOR MAIN SWITCH
Q2	— PUMP-FAN MAIN SWITCH
C1	— COMPRESSOR CONTACTOR
P1	— PUMP CONTACTOR
MC	— COMPRESSOR MOTOR
MV	— FAN MOTOR
MP	— PUMP MOTOR
CO1-2-3	— CAPACITOR START
B1	— REGULATION PROBE
B2	— ANTI FREEZE PROBE
B3	— EXTERNAL AIR TEMP. PROBE
PA	— HIGH PRESSURE SWITCH
PB	— LOW PRESSURE SWITCH
OLP	— COMPRESSOR OVERLOAD
TS	— AUX. TRANSFORMER
PR	— ON-OFF CONDENSING PRESSURE SWITCH
PD	— DIFF. PRESSURE SWITCH

SYMBOL AND NOTES

	CONNECTION POINT	
	CONNECTION TERMINAL BLOCK	(LAST N° 30 REF. 02.8)
	NORMALLY CLOSED CONTACTS	
	NORMALLY OPEN CONTACTS	
	INTERNAL UNIT WIRING	(LAST N° 108 REF. 01.5)
	FIELD SUPPLY WIRINGS	

MODEL	COMPRESSOR MOTOR				FAN MOTOR			PUMP MOTOR		TOTAL MAX POWER INPUT KW	MAX CURRENT INPUT A.	MAX L.R.A. A.	CABLE DIMENSION N°X mm
	POWER MAX	MAX CURRENT	MAX L.R.A.	MAIN SWITCH	POWER MAX	MAX CURRENT	MAIN SWITCH	POWER MAX	MAX CURRENT				
	N°X KW	N°X A	N°X A	N°X A	N°X KW	N°X A	N°X A	N°X KW	N°X A				
MECRO 6 US	1X2,4	1X12	1X64	1X16	1X0.21	1X0.9	1X6	1X0.37	1X2.8	2.98	15.7	67,7	2X4++ T

DISEGNO N°

85504105/013/B

FG. N°

003

DI

003