

All materials supplied are in compliance with the requirements of the list of Prohibited Substances

Sizes	Nominal flow scfm	Designation For 'G/NPT' thread	A	B	C	D	E	F	G	H	Mass wt (lbs)	PED category
1	95	M1/RM1/M01/RM01/AC/WS	5.7	5.2	7.6	2.5	1/4	1/4	-	-	1.6	Art. 4.3
2	150	M1/RM1/M01/RM01/AC/WS	6.9	6.3	8.8	2.5	3/8	1/4	-	-	1.8	Art. 4.3
3	265	M1/RM1/M01/RM01/AC/WS	11.0	9.2	14.2	4.3	1/2	1/4	2.8	1.7	7.6	Art. 4.3
4	325	M1/RM1/M01/RM01/AC/WS	11.0	9.2	14.2	4.3	3/4	1/4	2.8	1.7	7.6	Art. 4.3
5	490	M1/RM1/M01/RM01/AC/WS	14.4	12.5	17.5	4.3	1	1/4	2.8	1.7	9.1	CAT I
6	735	M1/RM1/M01/RM01/AC/WS	19.6	17.3	23.5	5.7	1 1/2	1/4	3.8	2.2	19.8	CAT I
7	1015	M1/RM1/M01/RM01/AC/WS	19.6	17.3	23.5	5.7	1 1/2	1/4	3.8	2.2	20.2	CAT I
8	1135	M1/RM1/M01/RM01/AC/WS	19.6	17.3	23.5	5.7	2	1/4	3.8	2.2	20.2	CAT I
9	1885	M1/RM1/M01/RM01/AC/WS	27.5	25.2	31.5	5.7	2	1/4	3.8	2.2	25.3	CAT I

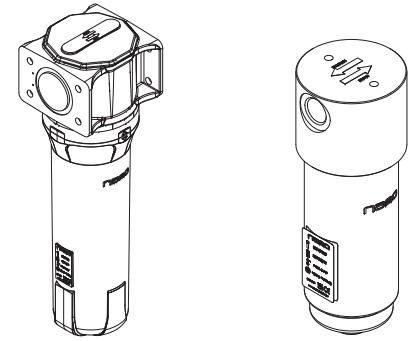

A-A (1 : 3)

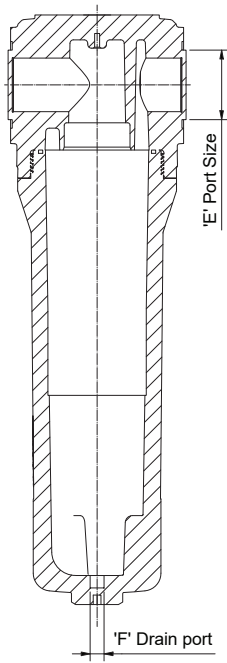

For Sizes 3-9

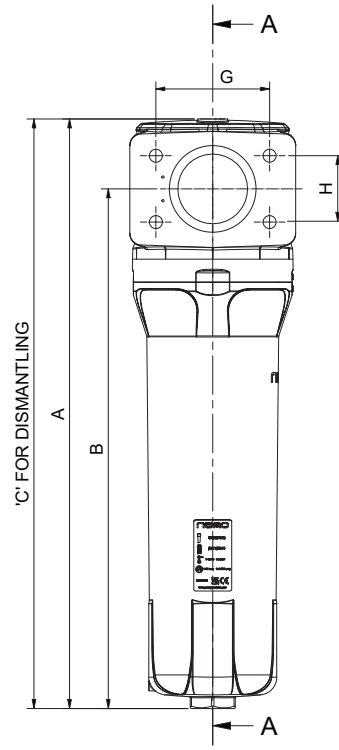
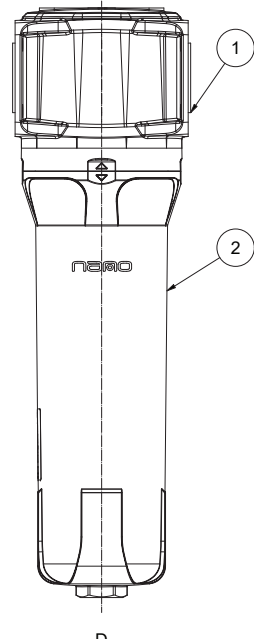
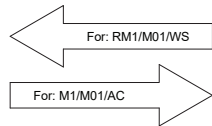

For Sizes 1-2

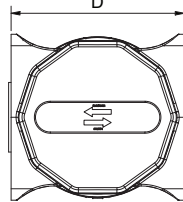
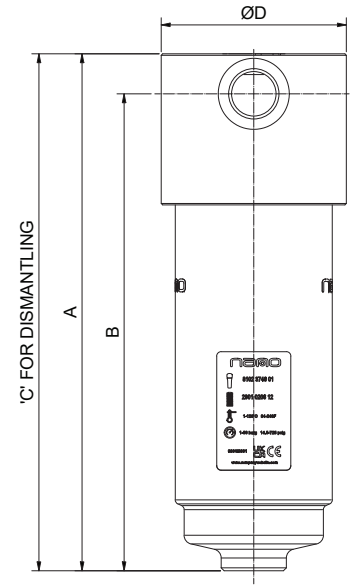
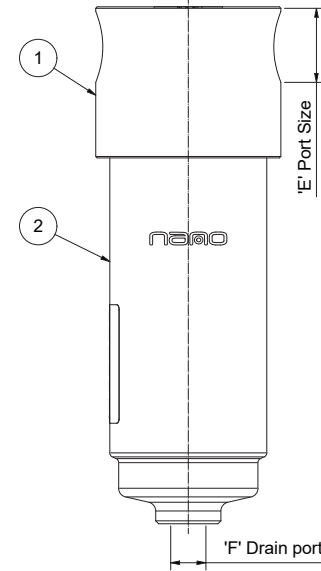
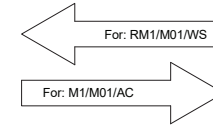

Item No.	Description	Material	Colour	Remark
1	HEAD	ALUMINIUM	BLACK	CAST HEAD
2	BOWL	ALUMINIUM	BLACK	CAST BOWL

NOTES:
1) All dimensions are in inches

Tolerances, if not indicated, according to:											
Name		DIMENS. DRWG 95 to 1885 (DIMENSION DWG.)					Confidentiality Class acc. to 1102 K		Confidential		
Material		See drawing					Treatment		See Drawing		
Scale		1 : 3		Family		A2/Compare		Drawing owner			
Version Drwg		a90005762		Blank nr.		Replaces		API			
STATUS		Blank wt		Kg Fini wt.		N/A		Designation			
Parent 3D model		Ed . Version 3D		WorkInProgress		Des checked.		Prod checked.		Approved. Date 02/06/2024	
										Sheet 2 / 2	
										9827700440-01	

CONFIDENTIAL: This document is our property and shall not be used without our permission. All rights reserved. No part of this document may be reproduced, stored in a retrieval system, or transmitted in any form or by any means, electronic, mechanical, photocopying, recording, or by any information storage and retrieval system, without prior written permission from our company.

Ed	Position	Modified from	Date	Intr./Appd.