

All materials supplied are in compliance with the requirements of the List of Prohibited Substances

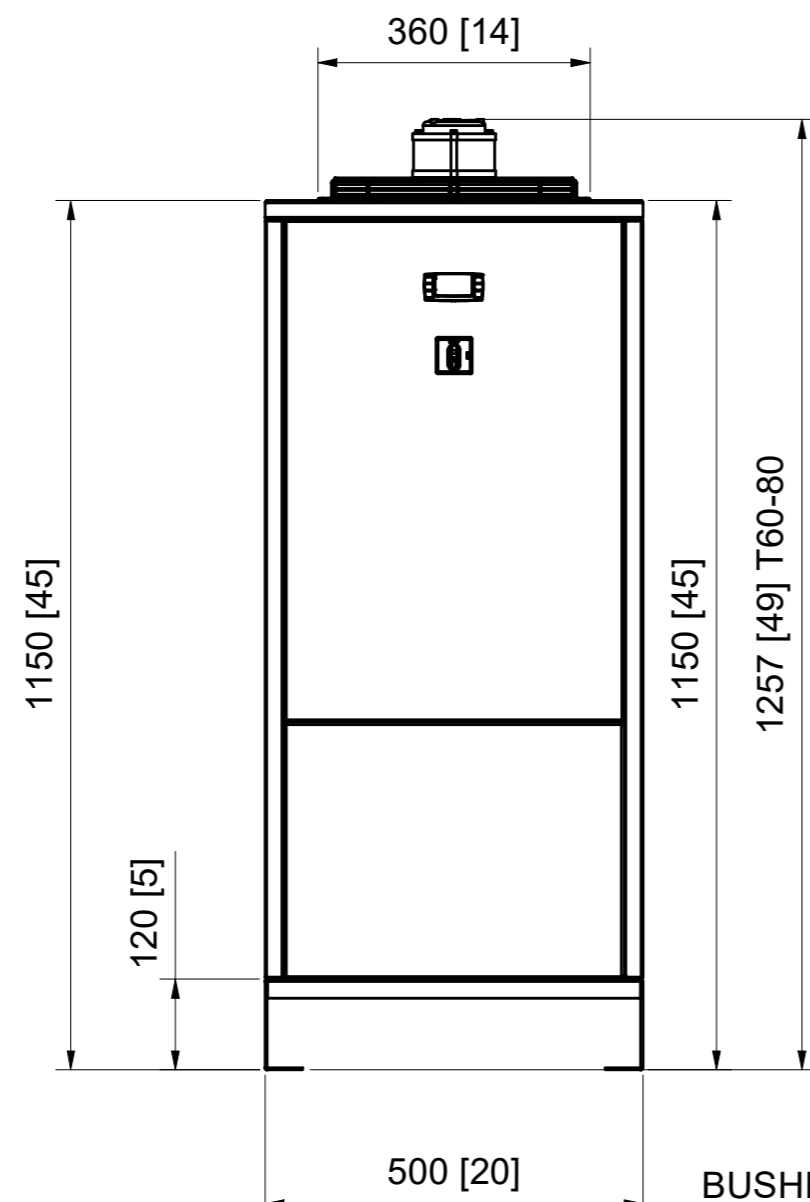

BUSHING  
UL VERSION ONLY

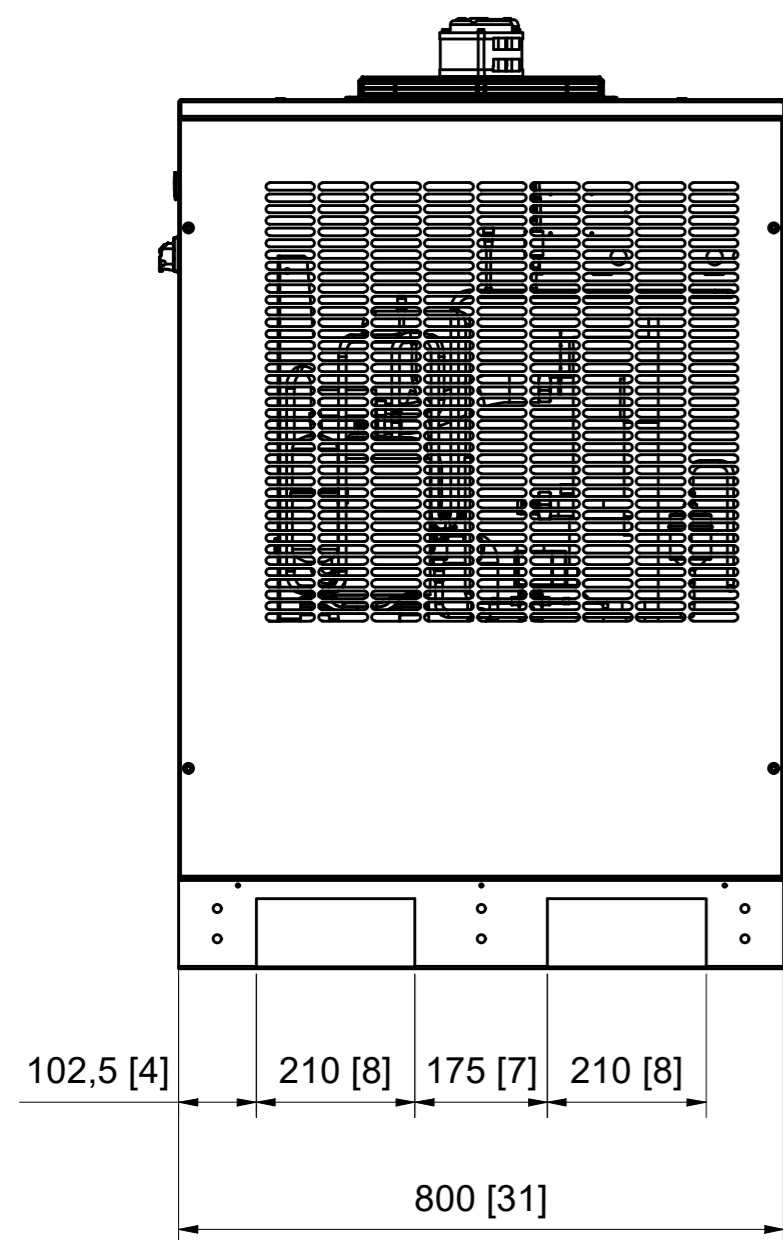
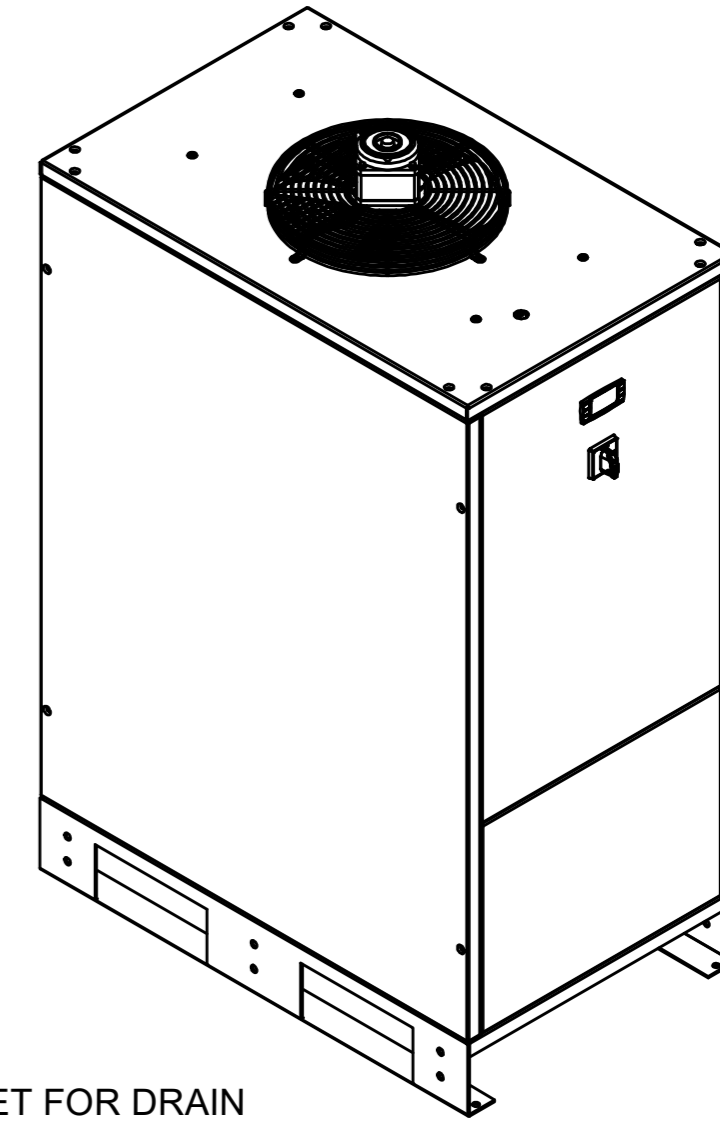
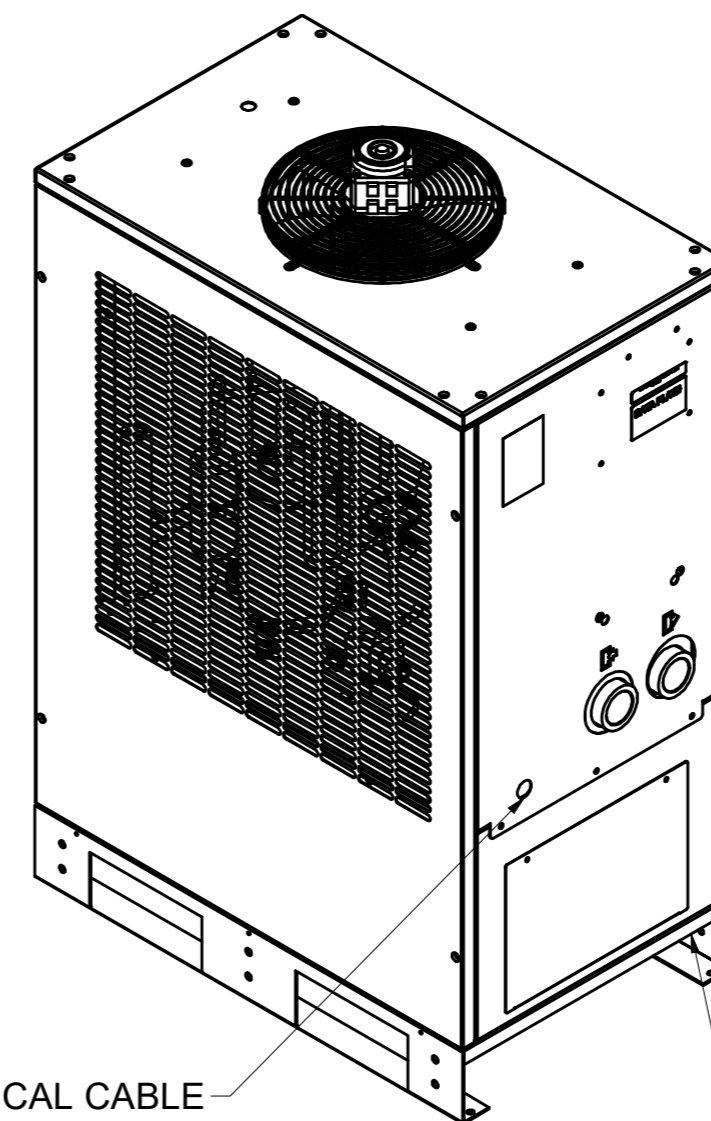
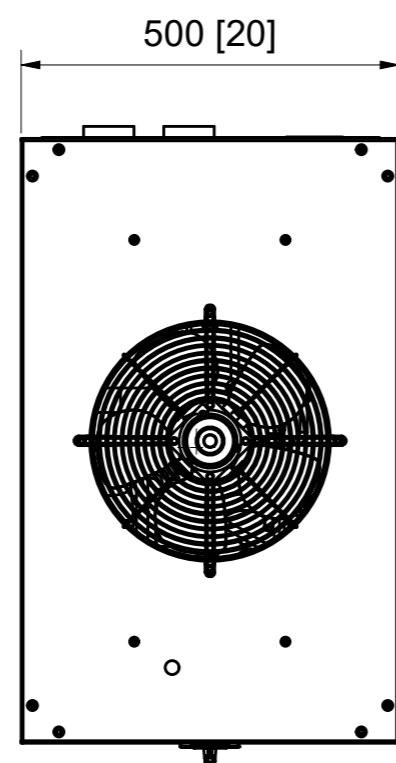
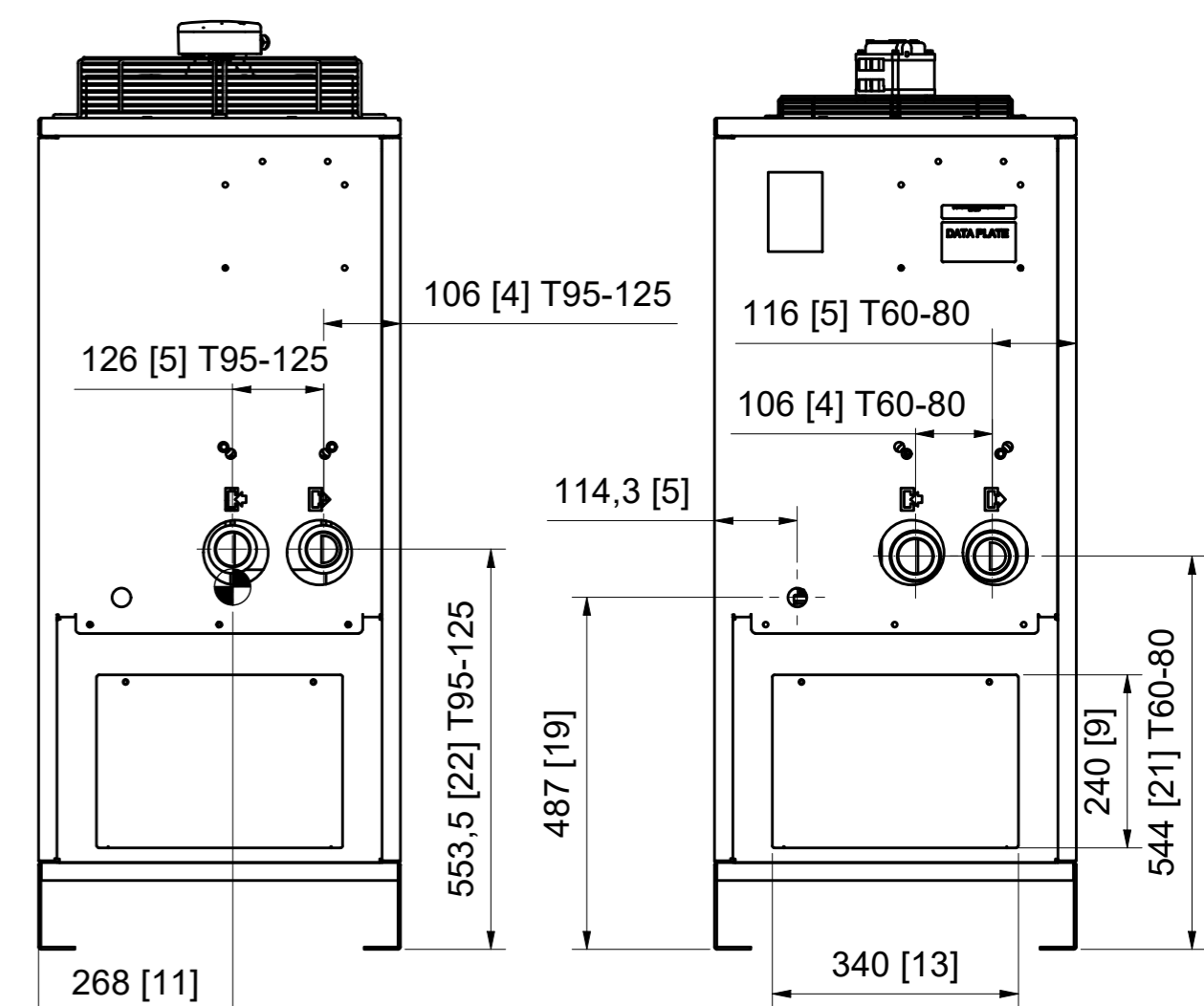
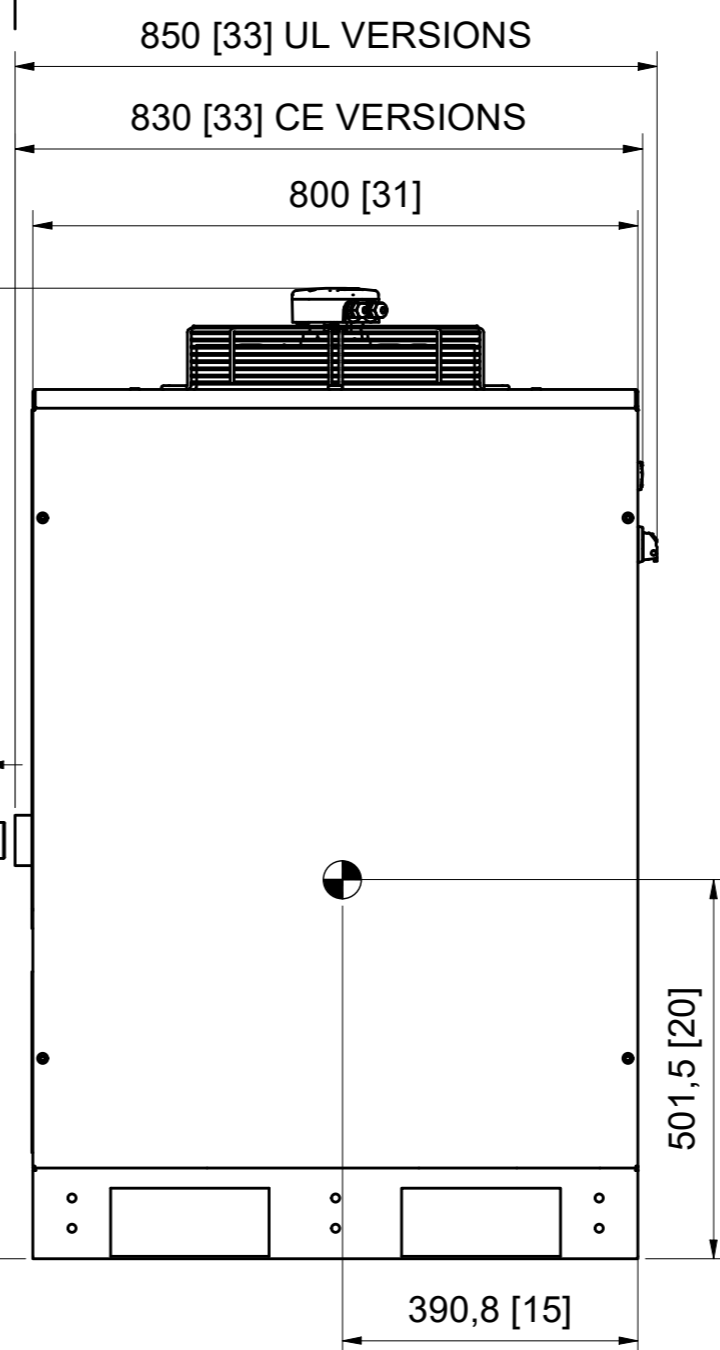

Air connections	CE (standard)	UL (bushings)
TMC 0130-0170N	1 1/2" GAS F	1 1/2" NPT F
TMC 0200-0265N	1 1/2" GAS F	1 1/2" NPT F

Centre of gravity  
All dimensions: mm [inch]

Tolerances, if not indicated, according to:					
Name	DIMENS. DRAWING TMC 0130 N - TMC 0265 N		Confidentiality Class	acc. to 1102 K	
Material			Internal		
Treatment	Not applicable		INV		
Scale	1 : 10	Family	T60-125	Compare	
Drawn by	CAlebetin	Blank nr.		Replaces	
Drawing format	Blank wt	Kg	Fini wt.	see ATR	Designation
STATUS		Des checked.		Prod checked.	Approved.
Parent 3D model		Ed . Version 3D		Date 3/02/2023	
9828084934				Approved Internal	
				8928084949	

CONFIDENTIAL: This document is property of nano-purification solutions and shall not be distributed without our permission. It is intended for manufacturing or communication to any other person or company.

00		First release. DN23054168.	17/10/2023	CAldelorenz
Ed	Position	Modified from	Date	Intr./Appd.

9828084934	
Parent 3D model	Ed . Version 3D

A  
B  
C  
D  
E  
F  
G