

PRIOR  
**C**

A = AIR INLET PIPE 4"  
B = AIR OUTLET PIPE 4"  
C = CONDENSATE DRAIN  
D = POWER SUPPLY

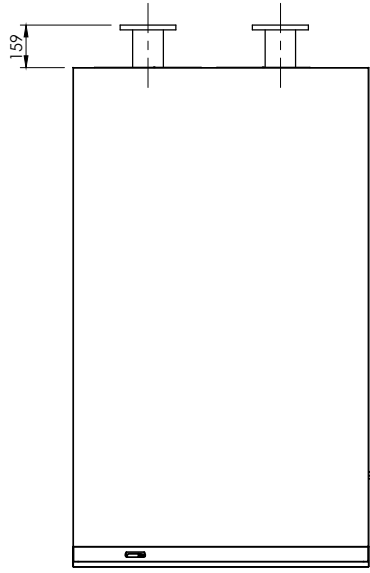

TOP VIEW

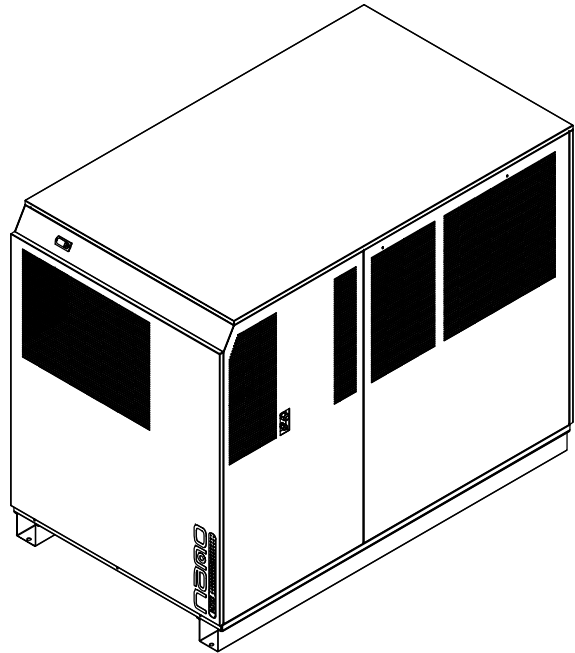

ISOMETRIC VIEW

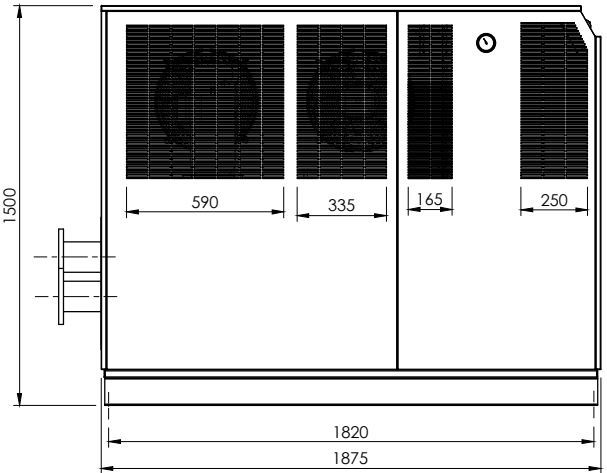

LEFT VIEW

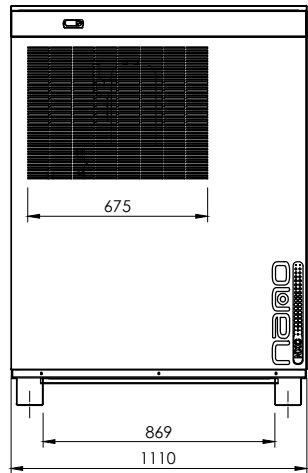

FRONT VIEW

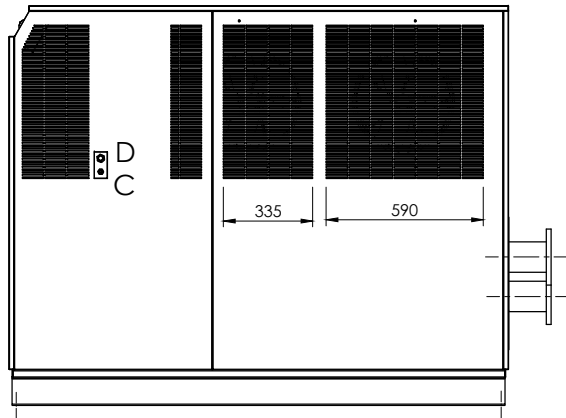

RIGHT VIEW

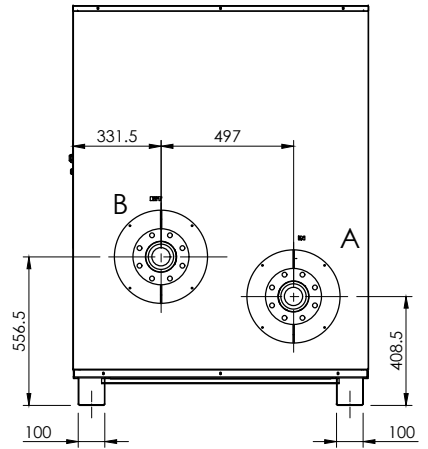

BACK VIEW

	THIRD-ANGLE PROJECTION	MAT'L : -	Q'TY : -	
	 Unit : mm	PAINTING : WHITE	DATE : FEB 28, 2018	SCALE : 1:30
TITLE / NAME : DIMENSION DRAWING , NXC1600-2000				
GEN. TOL. 1) DIM. 0 - 600 ±0.5 4) ANGLE ±1.0 2) DIM. 600 - 1500 ±1.0 3) DIM. 1500 UP ±2.0	DWG No. NXC1600-1-001	REV. : 01	SHEET :	