

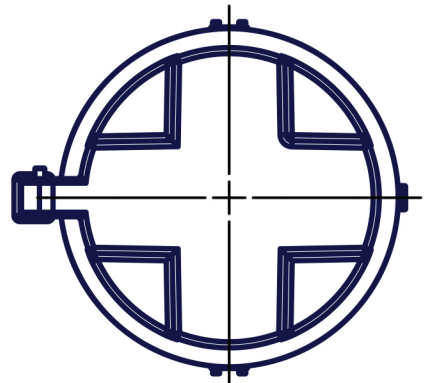

REV No	REVISION NOTE	DATE	SIGNATURE	CHECKED
1	production	09/02/18	dy	rp

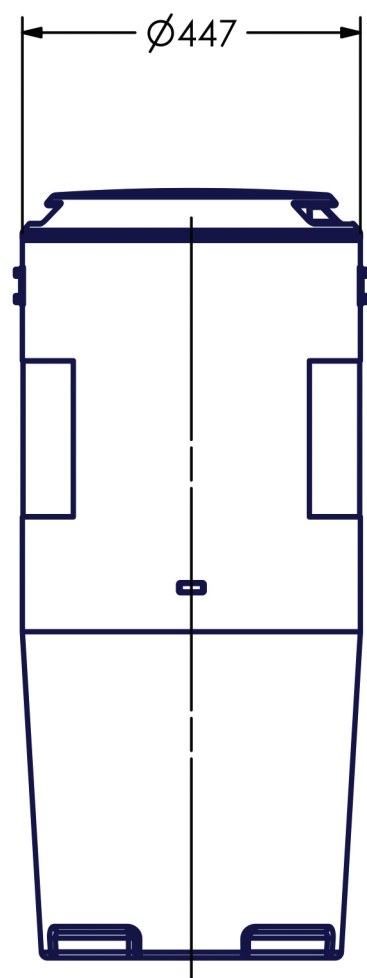
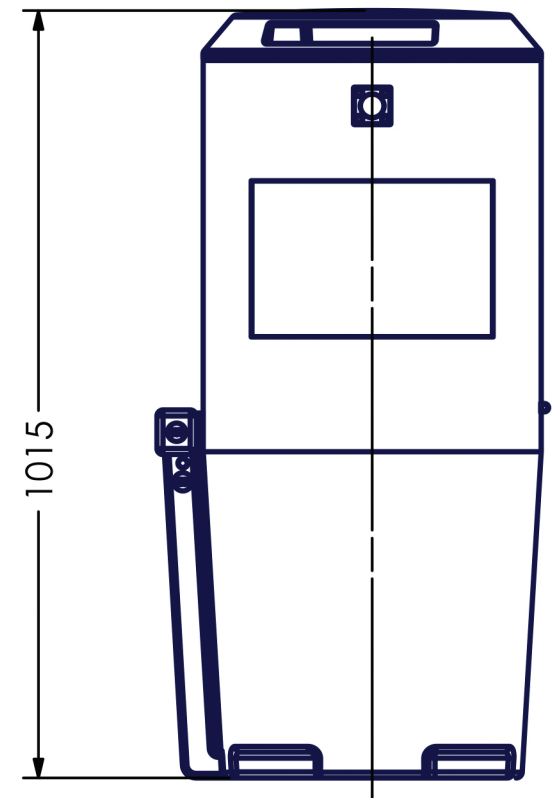
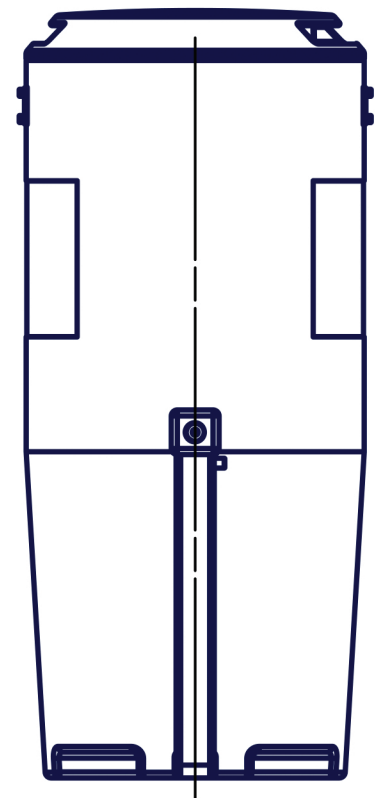
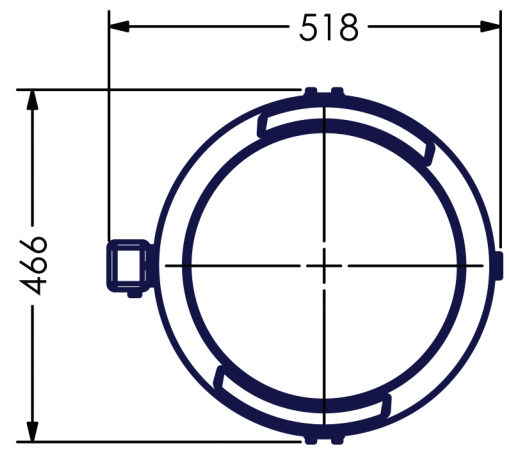

TOLERANCE-±5mm

SCALE 1-10	SHEET SIZE A3	NAME NSS 2100 Assembly
MATERIAL POLYETHYLENE		 www.nano-purification.com
DRAWN D YOUNG		
CHECK R POTTS		
APPR. R POTTS		
ISSUED 09-02-2018		
REV 1	DWG No BSL 1005	SHT No 1 of 1
PROJECTION 3rd		