

Code	
2200780127	04
Edit. 09/2020	

INSTRUCTION AND MAINTENANCE MANUAL

DRYERS

**E 5 - E 6
(R513A)**

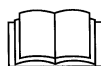
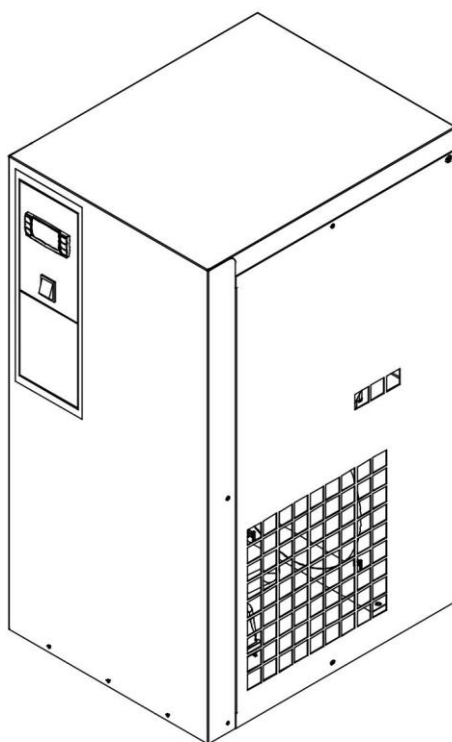

READ THIS MANUAL CAREFULLY BEFORE CARRYING OUT ANY OPERATIONS ON THE DRYER.

CONTENTS

PART A: INFORMATION FOR THE USER

- 1.0 GENERAL CHARACTERISTICS
- 2.0 INTENDED USE
- 3.0 OPERATION
- 4.0 GENERAL SAFETY STANDARDS
- 5.0 DESCRIPTION OF DANGER SIGNALS
- 6.0 DANGER ZONES
- 7.0 SAFETY DEVICES
- 8.0 POSITION OF PLATES
- 9.0 DRYERS ROOM
- 10.0 TRANSPORT AND HANDLING
- 11.0 UNPACKING
- 12.0 INSTALLATION
- 13.0 DIMENSIONS AND TECHNICAL DATA
- 14.0 MACHINE ILLUSTRATION
- 15.0 SCRAPPING THE DRYERS

PART B: INFORMATION RESERVED FOR TECHNICALLY SKILLED PERSONNEL

- 16.0 PARTIAL ROUTINE MAINTENANCE
- 17.0 TROUBLE-SHOOTING AND EMERGENCY REMEDIES
- 18.0 STARTING UP

ATTENTION: THERE IS A COPY OF THE WIRING DIAGRAM INSIDE THE ELECTRIC PANEL

ADDRESSES OF ASSISTANCE CENTRES

In the event of breakdown or malfunction of the dryer, switch it off and do not tamper with it. If repairs are needed, apply only to a technical assistance centre approved by the manufacturer and insist on the use of original spare parts. Failure to comply with the above may endanger the safety of the machine.

INTRODUCTION

Keep this manual with care for future consultation; the use and maintenance manual is an integral part on the dryer. Read this manual carefully before carrying out any operations on the dryer.

The installation of the dryer and all operations involving it must be performed in conformity with the regulations in force concerning electric plants and personal safety.

CHARACTERISTICS AND SAFETY PRECAUTIONS



**BEFORE REMOVING THE PROTECTIVE GUARDS TO CARRY OUT ANY MAINTENANCE ON THE MACHINE, SWITCH OFF THE ELECTRIC POWER SUPPLY AND DISCHARGE THE RESIDUAL PRESSURE INSIDE THE UNIT.
ALL WORK ON THE ELECTRIC PLANT, HOWEVER SLIGHT, MUST BE CARRIED OUT BY PROFESSIONALLY SKILLED PERSONNEL.**

The manufacturer does not accept responsibility for damage caused as a result of negligence or failure to abide by the instructions given above.

THIS MACHINE IS NOT SUITABLE FOR EXTERNAL INSTALLATION

THIS MACHINE CORRESPOND TO THE ESSENTIAL SAFETY REQUIREMENTS FORESEEN FROM THE EUROPEAN STANDARD (2006/42 CE).

THE LUBRICATING LIQUIDS AND OTHER EVENTUAL FLUIDS MUST NOT BE DISCHARGED IN THE ENVIRONMENT. THESE POLLUTING AND HAZARDOUS PRODUCTS MUST COMPULSORY BE DISPOSED BY CHARGING AUTHORISED AND SPECIALISED FIRMS ACCORDING TO THE DIFFERENT TYPOLOGY OF PRODUCT.

DIFFERENTIATE THE COMPRESSOR COMPONENTS ACCORDING TO THE DIFFERENT CONSTRUCTION MATERIALS (PLASTIC, COPPER, IRON, OIL FILTER, AIR FILTER ECC...)

1.0 GENERAL CHARACTERISTICS

The dryer is a chilling machine with direct expansion and dry evaporator. The air to be dried is sent to the heat exchanger in which the water vapour present is condensed: the condensate gathers in the separator and is discharged outside through a steam trap.

2.0 INTENDED USE

The dryer has been built to dry the compressed air for industrial use. The dryer cannot be used in premises where there is a risk of fire or explosion or where work is carried out which releases substances into the environment which are dangerous with regard to safety (for example: solvents, inflammable vapours, alcohol, etc.).

In particular the appliance cannot be used to produce air to be breathed by humans or used on direct contact with foodstuffs. These uses are allowed if the compressed air produced is filtered by means of a suitable filtering system (Consult the manufacturer for these special uses.)

This appliance must be used only for the purpose for which it was specifically designed. All other uses are to be considered incorrect and therefore unreasonable. The Manufacturer cannot be held responsible for any damage resulting from improper, incorrect or unreasonable use.

3.0 OPERATION

The gaseous refrigerant coming from the evaporator (4) is sucked by the refrigeration compressor (1) and it is pumped into the condenser (2). This one allows its condensation, eventually with the help of the fan (3); the condensed refrigerant passes through the dewatering filter (8) and it expands through the capillary tube (7) and goes back to the evaporator where it produces the refrigerating effect. Due to the heat exchange with the compressed air which passes through the evaporator against the stream, the refrigerant evaporates and goes back to the compressor for a new cycle.

The circuit is equipped with a bypass system for the refrigerant; this intervenes to adjust the available refrigerating capacity to the actual cooling load. This is achieved by injecting hot gas under the control of the valve (9): this valve keeps constant the pressure of the refrigerant in the evaporator and therefore also the dew point never decreases below (0 °C / 32 ° F) in order to prevent the condensate from freezing inside the evaporator. The dryer runs completely automatically.

DRYER FLOW DIAGRAM

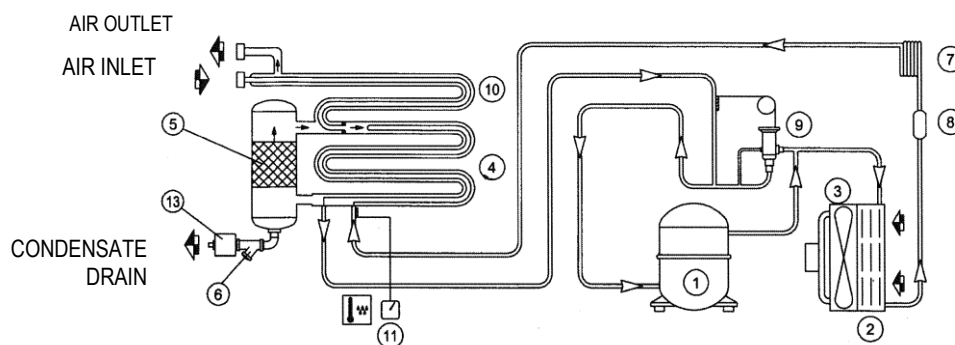

1) REFRIGERANT COMPRESSOR	8) REFRIGERANT FILTER
2) CONDENSER	9) HOT GAS BYPASS VALVE
3) MOTOR FAN	10) AIR-TO-AIR EXCANGER
4) EVAPORATOR	11) DIGITAL CONTROLLER
5) DEMISTER CONDENSATE SEPARATOR	13) CONDENSATE DRAIN
6) IMPURITY TRAP	
7) EXPANSION CAPILLARY TUBE	

4.0 GENERAL SAFETY STANDARD

The appliance may be used only by specially trained and authorized personnel.





Any tampering with the machine or alterations not approved beforehand by the Manufacturer relieve the latter of responsibility for any damage resulting from the above actions.

The removal of or tampering with the safety devices constitutes a violation of the European Standards on safety.



ALL WORK ON THE ELECTRIC PLANT, HOWEVER SLIGHT, MUST BE CARRIED OUT BY PROFESSIONALLY SKILLED PERSONNEL.

5.0 DESCRIPTION OF DANGER SIGNALS

				
1) Dangerous electricvoltage	2) Air not fit for breathing	3) High pressure	4) Fan rotating	5) Hot parts

6.0 DANGER ZONES

6.1 DANGER ZONES

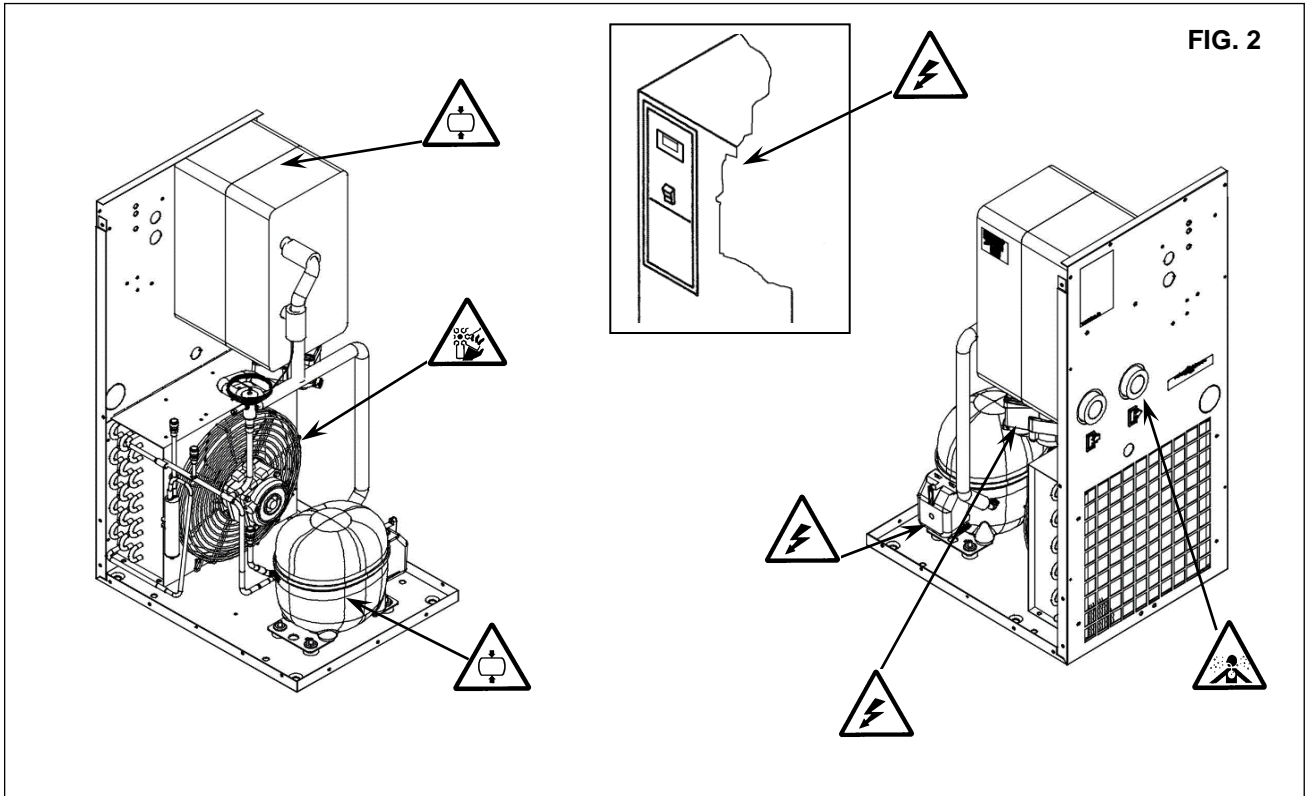
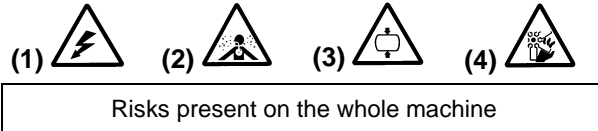

7.0 SAFETY DEVICES

7.1 SAFETY DEVICES

1) Cooling fan shield	2) Earth
-----------------------	----------

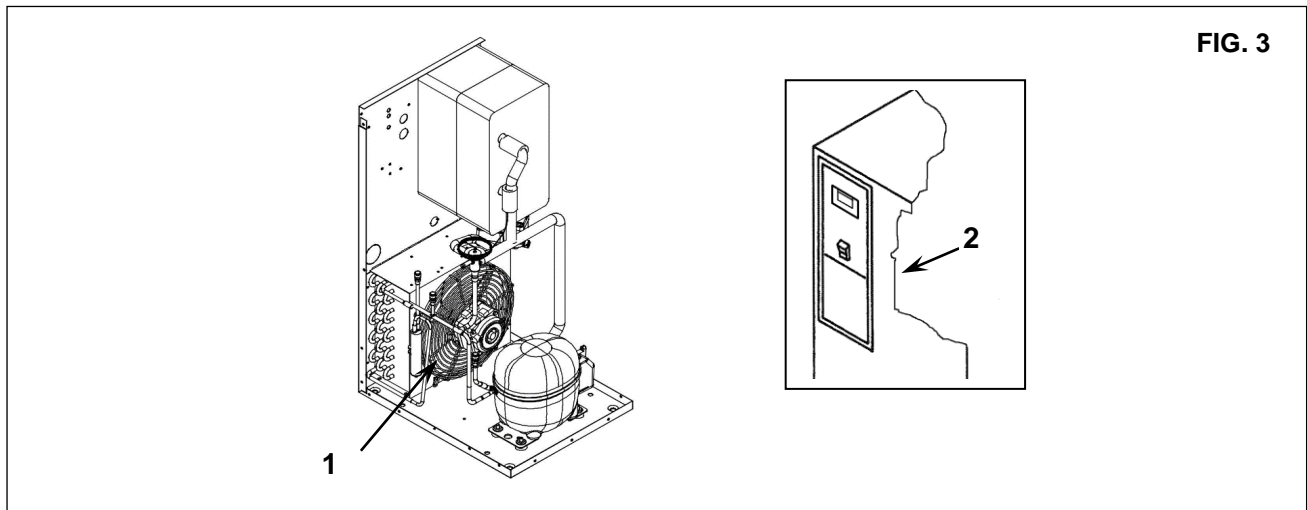

8.0 POSITION OF PLATES

8.1 POSITION OF THE DANGER PLATES (Fig. 4)

The plates fitted on the compressor unit are part of the machine; they have been applied for safety purposes and must not be removed or spoiled for any reason.

Ref.1 - Spare plate Code 1079 9903 48

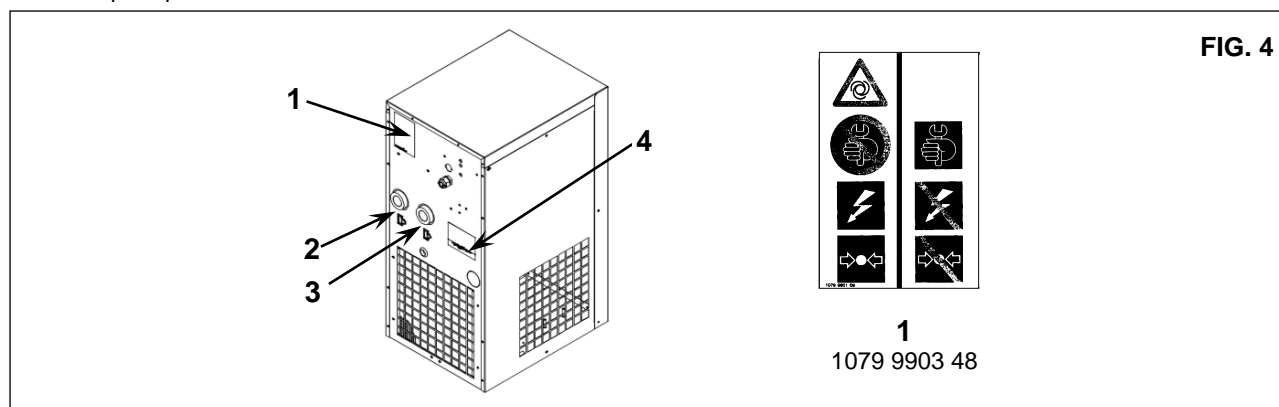

8.2 POSITION OF THE DATA PLATES (Fig. 4)

Ref. 2) "IN"	Ref. 4) Identification plate
Ref. 3) "OUT"	

9.0 DRYERS ROOM

9.1 FLOOR

The floor must be even and of industrial type; the total weight of the machine is shown in Fig. 5
Remember the total weight of the machine when positioning it.

9.2 VENTILATION

The choice of an appropriate room will prolong the life of your dryer; the room must be spacious, dry, well ventilated and free from dust.

The operating conditions to be complied with are the following:

Min. room temperature: + 5 °C (+ 41 °F) (compulsory)	Min. temperature of incoming air: 10 °C (50 °F)
Max. room temperature: + 43 °C (+ 109 °F) (compulsory)	Max. working pressure: 14 bar (203 psi)
Max. temperature of incoming air: 55 °C (131 °F)	

- Please keep environmental conditions stable (temperature and humidity) in order to avoid refrigerant compressor/fan overload and/or reduction of dryer performance. Similar failures shall affect warranty reimbursements.
- Please ensure the appropriate composition of the air within the machine room: - clean with no damaging contaminants (e.g., dust, fibers, fine sand) - free of explosive or chemically unstable gases or vapors - free of acid/alkaline forming substances, particularly ammonia, chlorine or hydrogen sulfide. Similar failures shall affect warranty reimbursements.
- Please remember that we do not recommend the application of duct to extract air in presence of axial fans.

10.0 TRANSPORT AND HANDLING

The machine must be transported as shown in the following figures.

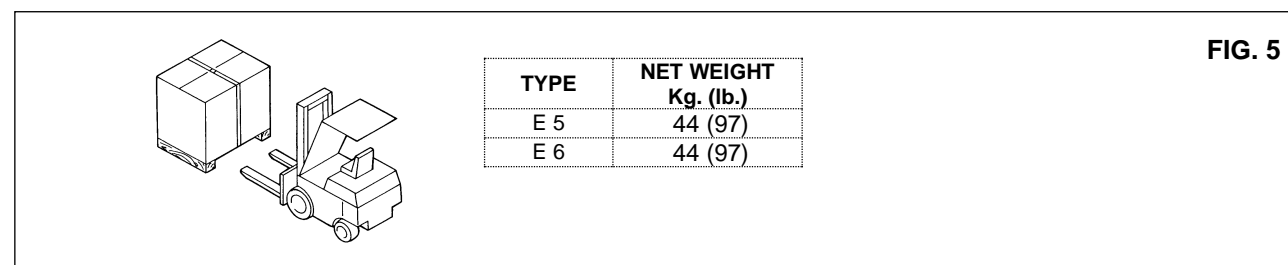

11.0 UNPACKING



CUTTING THE METAL STRAPPING IS A DANGEROUS OPERATION, DO NOT ABANDON THE CUT PIECES IN THE ENVIRONMENT.

After removing the packing, ensure that the machine is unbroken and that there are no visibly damaged parts.

If you are in doubt, do not use the machine but apply to the manufacturer technical assistance service or to your dealer.

The packing material (plastic bags, polystyrene foam, nails, screws, wood, metal strapping, etc.) must not be left within the reach of children or abandoned in the environment, as they are a potential source of danger and pollution. Dispose of these materials in the approved collection centres.

12.0 INSTALLATION

12.1 POSITIONING

After unpacking the equipment and preparing the dryers room, put the machine into position, checking the following items:

- ensure that there is sufficient space around the machine to allow maintenance (see Fig. 6).

ENSURE THAT THE OPERATOR CAN SEE THE WHOLE MACHINE FROM THE CONTROL PANEL AND CHECK THE PRESENCE OF ANY UNAUTHORIZED PERSONS IN THE VICINITY OF THE MACHINE.

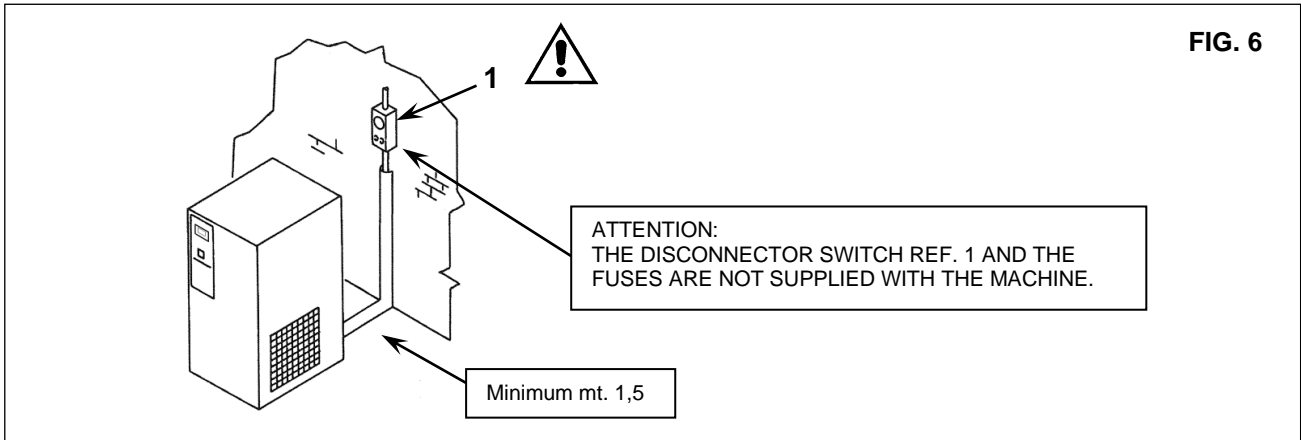

12.2 ELECTRICAL CONNECTION

- Check that the supply voltage is the same as the value indicated on the machine data plate.
- Check the condition of the line leads and ensure that there is an efficient earth lead.
- **Ensure that there are disconnect switch Ref. 1 Fig. 6 and fuses upstream the machine. For details (size and type) see wiring/service diagram.**



ONLY PROFESSIONALLY SKILLED PERSONNEL MAY HAVE ACCESS TO THE ELECTRIC PANEL. SWITCH OFF THE POWER BEFORE OPENING THE DOOR OF THE ELECTRIC PANEL. COMPLIANCE WITH THE REGULATIONS IN FORCE CONCERNING ELECTRIC PLANTS IS FUNDAMENTAL FOR OPERATOR SAFETY AND FOR THE PROTECTION OF THE MACHINE.

12.3 CONNECTION TO THE COMPRESSED AIR NETWORK

Fit a manual interception valve Ref. 1 between the machine and the compressed air network so that the dryer may be isolated during maintenance operations (see figure 7).
Drainage of condensate Rif. 2 Fig. 7 (automatic) are led outside the machine with a flexible pipe that may be inspected.
Drainage must comply with the local regulations in force.

- All refrigerant dryers shall be equipped with proper pre-filter at closest position to dryer air inlet (to be replaced according to service plan: once per year or even before in case of particular high humidity ambient conditions).



ALL DAMAGE DUE TO THE FAILURE TO COMPLY WITH THESE INDICATIONS CANNOT BE ATTRIBUTED TO THE MANUFACTURER AND MAY CAUSE INVALIDITY OF THE GUARANTEE CONDITIONS.

12.4 STARTING UP

See part B of this manual, Chapter 18.0

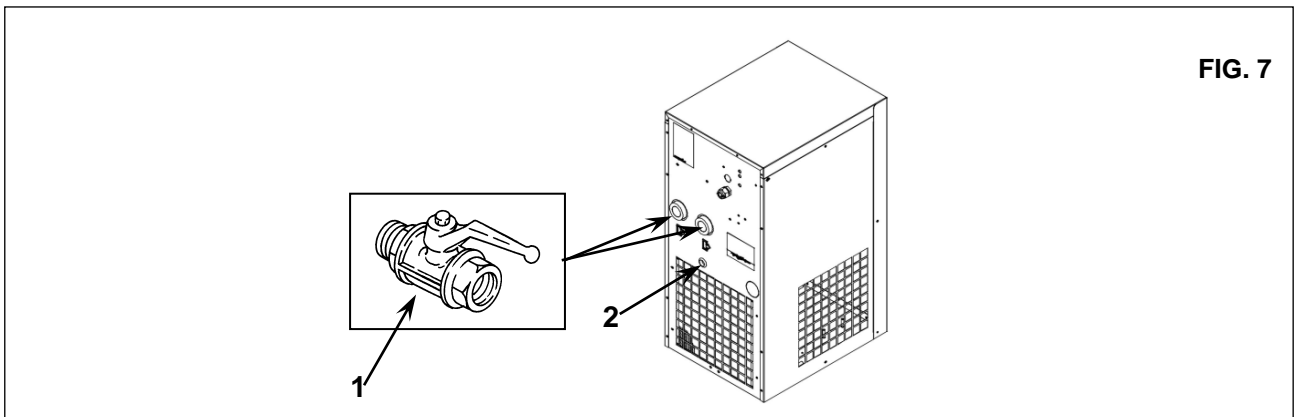

13.0 DIMENSIONS AND TECHNICAL DATA (E5 - E6)

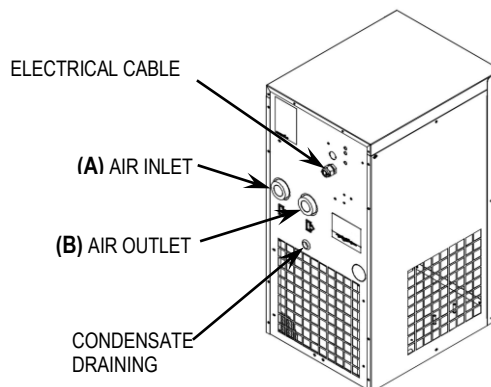
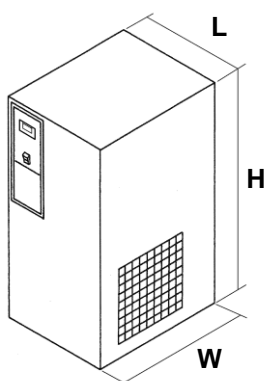

TYPE	in (mm)		
	L	W	L
E 5	370 (14,57)	515 (20,28)	764 (30,08)
E 6	370 (14,57)	515 (20,28)	764 (30,08)

Refrigerant gas ⁽¹⁾	GWP ₁₀₀ ⁽²⁾
R-513A	631
⁽¹⁾ According to ISO 817	
⁽²⁾ According to EN-378-1	

TYPE	A	B
E 5	1" GAS F.	1" GAS F.
E 6	1" GAS F.	1" GAS F.

TYPE	Weight Kg. (lb.)	V230 Freon R513A Kg. (lb.)			Nominal Power W (hp)			Nominal Power W (hp)			bar (psi) MAX. 	
		50 Hz	230-115/60 Hz	50 Hz	230/60 Hz	115/60 Hz	50 Hz	230-115/60 Hz	50 Hz	230/60 Hz		115/60 Hz
E 5	44 (97)	0.33	0.33 (0,728)	609	659 (0,884)	616 (0,826)	65	57 (0,076)	674	726 (0,974)	673 (0,903)	14 (203)
E 6	44 (97)	0.30	0.30 (0,661)	651	706 (0,947)	660 (0,885)	65	57 (0,076)	716	763 (1,023)	717 (0,962)	14 (203)

Reference conditions:

Ambient temperature 25 °C (77 °F)
 Inlet air temperature 35 °C (95 °F)
 Working pressure 7 bar (102 psi)

Limit conditions:

Max. ambient temperature 43 °C (109 °F)
 Min. ambient temperature 5 °C (41 °F)
 Max. inlet air temperature 55 °C (131 °F)
 Max. working pressure 14 bar (203 psi)

14.0 MACHINE ILLUSTRATION

14.1 GENERAL LAY-OUT

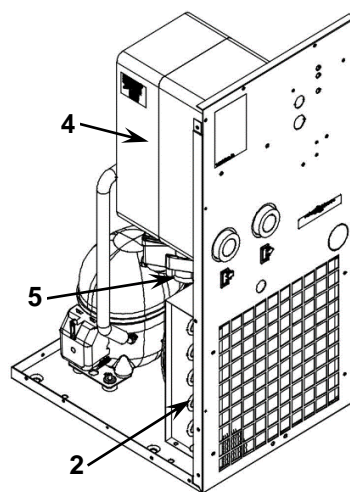
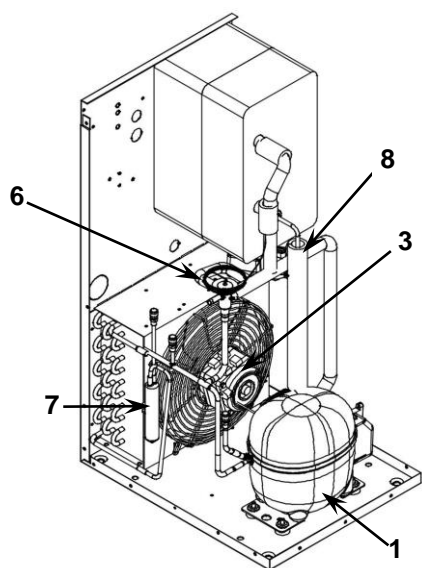

FIG. 8

1	Refrigerant compressor
2	Condenser
3	Motor fan
4	Evaporator
5	Condensate drain
6	Hot gas by-pass valve
7	Refrigerant filter
8	Expansion capillary tube

14.2 COMMAND AND CONTROL PANEL



BEFORE CARRYING OUT THE OPERATION TEST, READ CAREFULLY AND ACQUIRE A GOOD KNOWLEDGE OF THE COMMAND FUNCTIONS.

Ref. 1) Digital controller
 Ref. 7) Stop - Running button

FIG. 9

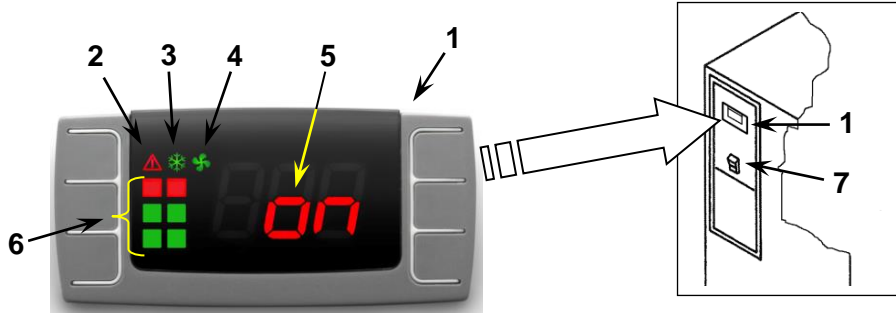

2	Alarms
3	Power ON
4	Fan ON
5	Dryer ON
6	PDP indicator

	<i>ICON</i>	<i>MODE</i>	<i>FUNCTIONS</i>
	ALARM	OFF	No active alarms
		ON	Probe failure alarm High/Low temperature alarm
	COMPRESSOR	OFF	Dryer off
		FLASH	Maintenance warning
		ON	Dryer on
	FAN	OFF	Fan off
		FLASH	n/a
		ON	Fan on

14.3 COMMAND AND CONTROL PANEL (Option "free contact")



BEFORE CARRYING OUT THE OPERATION TEST, READ CAREFULLY AND ACQUIRE A GOOD KNOWLEDGE OF THE COMMAND FUNCTIONS.

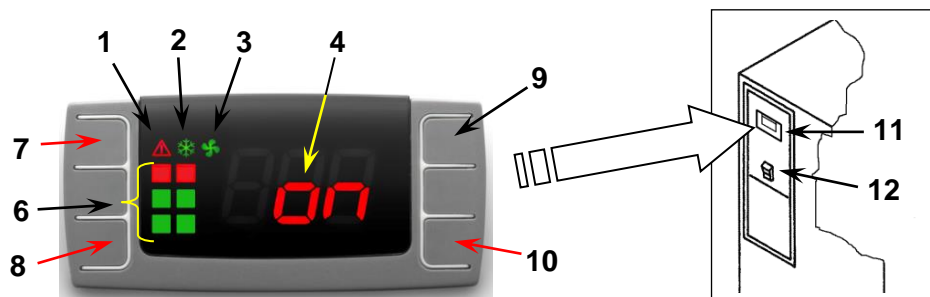

FIG. 9a

Reference	Name
1	Alarm icon
2	Refrigerant compressor icon
3	Fan icon
4	Dryer ON
6	PDP indicator
7	Button to snooze or to reset the alarm
8	SET button
9	UP button
10	DOWN button
8 + 9	Back to previous screen
8 + 10	Menu
11	Digital controller
12	Switch

ICONS

ICON	NAME	MODE	FUNCTIONS
	Alarm	OFF	No active alarms
		ON	Probe failure alarm
		ON	High/Low temperature alarm
		ON	Service alarm
	Refrigerant compressor	OFF	Dryer off
		ON	Dryer on
		Flashing + SE	Maintenance warning
		Flashing + L2	Dewpoint too low / Dryer is stopped
		Flashing + Countdown	Residual time before start
	Fan	OFF	Fan off
		Flashing	Not applicable
		ON	Fan on

REMOTE ALARM FUNCTION

The controller allows to remotely control a number of alarms. This is managed by means of a free NC (Normally Closed) contact.

The contact opens in case of an alarm or when the dryer is switched off.

Refer to the table below to identify the availability of the function and refer to the related picture Fig. 9b Ref. 1 to identify the physical location of the free contact connector.

Is possible remote alarm for P1, P2, P3, L2, H2 and H3. For the details of alarm see Cap. 17.2 Pag. 17.



FIG. 9b

Location of the free contact connector (1)

15.0 SCRAPPING THE UNIT

If the machine is to be scrapped, it must be dismantled into parts of the same material, to be disposed of according to the local regulations in force.

ALWAYS RESPECT THE REGULATIONS IN FORCE FOR DISPOSING OF OLD OIL AND OTHER POLLUTING MATERIALS SUCH AS INSULATING FOAM, ETC.

PART "B"



THIS PART "B" OF THE INSTRUCTIONS MANUAL IS RESERVED FOR PROFESSIONALLY SKILLED PERSONNEL APPROVED THE MANUFACTURER.

16.0 PARTIAL ROUTINE MAINTENANCE



BEFORE CARRYING OUT ANY MAINTENANCE JOBS IT IS OBLIGATORY TO STOP THE MACHINE AND DISCONNECT IT FROM THE POWER MAINS AND FROM THE COMPRESSED AIR DISTRIBUTION NETWORK.

16.1 MAINTENANCE SCHEDULE

These maintenance intervals are recommended for work environments that are not dusty and are well ventilated. For particularly dusty environments, double the frequency of controls.

Every week	■ ■	Brush/blow off the finned surface of the condenser
	■ ■	Clean the filter of the automatic condensate drain
Every 2000 hours / 1 year	■ ■	Replace the filter of automatic condensate drain (2902016102)
Every 4000 hours / 2 year	■ ■	Replace drain kit (2200902017)

16.2 CLEANING OF THE AUTOMATIC CONDENSATE DISCHARGER FILTER (Fig. 10)

Clean the filter of the steam trap.

Proceed as follows:

- Close the cock Ref. 1 Fig. 10
- Release the pressure in the dryer by pressing the condensate drain "TEST" pushbutton located on the steam trap Ref. 2 Fig. 10.
- Switch off the machine by pressing the STOP button Ref. 3 Fig. 10
- Turn on the supply automatic differential switch Ref. 4 Fig. 10



HOT PARTS INSIDE

- Remove the panels Ref. 5
- Remove the stopper Ref. 6
- Remove the filter Ref. 7
- Clean the filter Ref. 5 with a jet of air, working from inside to outside
- Install the filter, fix the plug Ref. 7 - 6
- Close the panels Ref. 5

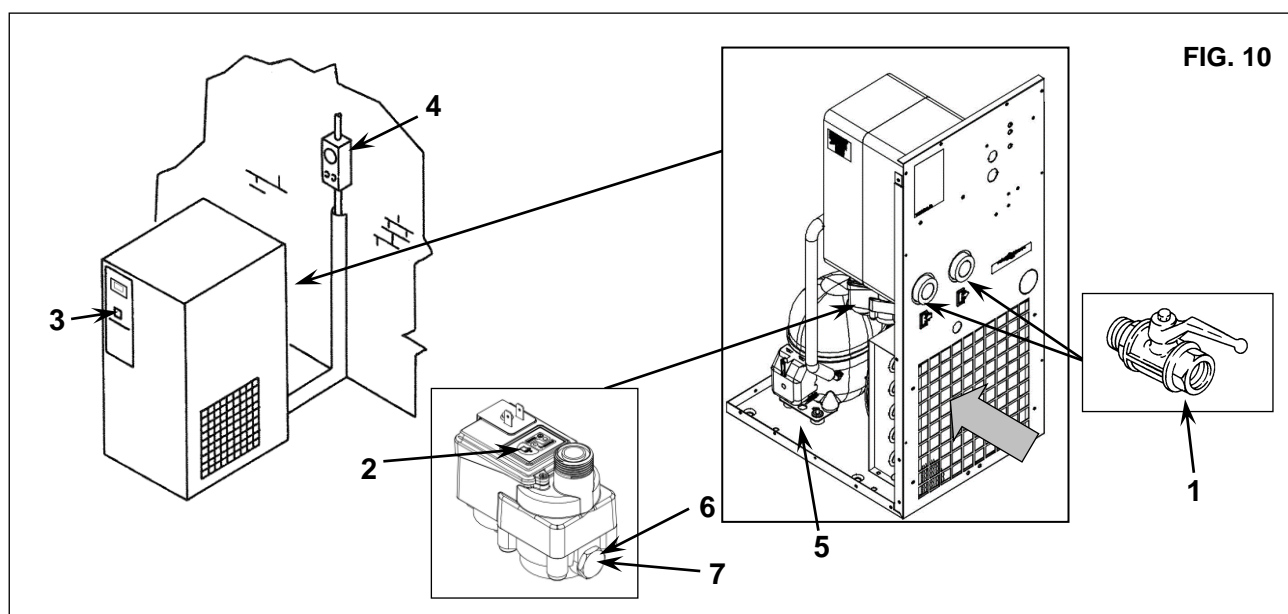

FIG. 10

16.3 CLEANING THE CONDENSER (Fig. 10)

The condenser must be cleaned every month.

Proceed as follows:

- Switch off the machine by pressing the STOP button Ref. 3 Fig. 10
- Turn on the supply automatic differential switch Ref. 4 Fig. 10
- Remove the panels Ref. 5 Fig. 10
- Clean the condenser fins Ref. 1 with compressed air (Fig. 10) **DO NOT USE WATER OR SOLVENTS**
- Close the panels Ref. 5 Fig. 10

17.0 TROUBLE-SHOOTING AND EMERGENCY REMEDIES











ALL WORK MUST BE CARRIED OUT BY PROFESSIONALLY SKILLED PERSONNEL. BEFORE CARRYING OUT ANY MAINTENANCE JOBS IT IS OBLIGATORY TO STOP THE MACHINE AND DISCONNECT IT FROM THE POWER MAINS.

N.B. OPERATIONS MARKED ■ ■ MUST BE CARRIED OUT BY PROFESSIONALLY SKILLED PERSONNEL APPROVED THE MANUFACTURER

FAULT FOUND	POSSIBLE CAUSES	OBSERVATIONS
1) No compressed air passes through the dryer outlet	1A) The pipes are frozen inside	<ul style="list-style-type: none"> ■ ■ -The bypass valve of the hot gas is broken or out-of-calibration -The room temperature is too low and the evaporators piping are obstructed with ice
2) Presence of condensate in the pipings.	2A) The condensate separator does not work correctly	<ul style="list-style-type: none"> -Clean the filter from the condensate drain ■ ■ -Check the condensate drain
	2B) The dryer is working outside its rating	<ul style="list-style-type: none"> -Check the flow rate of treated air -Check the room temperature -Check the air temperature at the drier inlet.
	2C) The dryer is working under bad conditions of condensation	<ul style="list-style-type: none"> -Clean the condenser. ■ ■ -Check the good operation of the fan.
3) The compressor head is very hot (> 55 °C)	Make reference to 2B Make reference to 2C 3A) The cooling circuit is not working with the right gas charge	<ul style="list-style-type: none"> ■ ■ -Check if there are leaks of refrigerating gas. ■ ■ - Charge it again.
4) Motor cuts out on overload	Make reference to 2B Make reference to 2C Make reference to 3A	
5) The motor hums and does not start.	The line voltage is too low. You switched the machine off and on again without leaving enough time for the pressure balancing. The starting system of the motor is defective.	<ul style="list-style-type: none"> -Contact the electric power company -Wait a few minutes before starting the machine again. ■ ■ -Check the running and starting relays and condensers (if any)
6) The machine has stopped and does not restart even after a few minutes.	The overload protection has intervened: make reference to 2B-2C-3A.	
	The motor has burnt out.	
7) The compressor is very noisy.	Troubles with the internal mechanical parts or with the valves	

17.1 TROUBLE-SHOOTING AND EMERGENCY REMEDIES

N.B. OPERATIONS MARKED ■ ■ MUST BE CARRIED OUT BY PROFESSIONALLY SKILLED PERSONNEL APPROVED THE MANUFACTURER

DISPLAY	FLASHING WARNING	NOTES	Possible root causes	Observations
		Dryer is working OK	n/a	n/a
				
		Warning icon NOT flashing, label P1 flashing	Fan control probe failed	■■ replace probe
		Warning icon NOT flashing, label P2 flashing	PDP Temp probe failed	■■ replace probe
		Warning icon NOT flashing, label H2 flashing	High PDP call for service	■■ refrigerant leak ■■ flow rate / inlet ■■ temperature exceeding the limit.
		Warning icon NOT flashing, label L2 flashing	Low PDP call for service	■■ hot gas by pass valve out of order. ■■ ambient temperature lower then limits

EE ALARM

EE alarm is shown when internal EPROM errors happens, if this warning will appear, the dryer will stop running. The error can be reset by pressing one of the four buttons of the controller, anyway please replace the controller itself.



NOTE: In case of EE alarm please contact your tech support.

SE ALARM









After 6000Hrs, the controller will issue a "SE" warning. This is the maintenance due warning.



How to reset the maintenance warning: follow steps 1 to 12

<p>1</p> <p>PDP is flashing between standard view and "SE" alarm</p>	<p>2</p> <p>Push and hold buttons "SET" and "DOWN" to enter in the menu.</p>	<p>3</p> <p>Message "SE" appears on display.</p>
<p>4</p> <p>Push and release button "UP".</p>	<p>5</p> <p>Message "rS" appears on display.</p>	<p>6</p> <p>Push and release button "SET".</p>
<p>7</p> <p>Message "n" appears on display.</p>	<p>8</p> <p>Push and release button "UP".</p>	<p>9</p> <p>Message "y" appears on display.</p>
<p>10</p> <p>Push and release "SET" to reset service alarm.</p>	<p>11</p> <p>Message "y" blinks for 3 seconds.</p>	<p>12</p> <p>Then "rL" is fixed and "°C" blinks on display for ~10 seconds. Service alarm is reset</p>

PROCEDURE TO SET THE SERVICE INTERVAL ON PDP DEVICE

<p>1</p>	 <p>PDP is showing standard view.</p>	<p>2</p>  <p>Push and hold buttons "SET" and "DOWN" to enter in the menu.</p>	<p>3</p>  <p>Message "SE" appears on display.</p>
<p>4</p>	 <p>Push and release "SET" to enter in the "SE" menu.</p>	<p>5</p>  <p>Current service interval is displayed. ("60" or different value from "0" to "99")</p>	<p>6</p>  <p>Select desired service interval using "UP" or "DOWN". (40=4000h, 55=5500h, 80=8000h,...)</p>
<p>7</p>	 <p>Push and release "SET" to configure new service interval.</p>	<p>8</p>  <p>Value selected blinks for 3 seconds.</p>	<p>9</p>  <p>Then "rS" is fixed and "°C" blinks on display for ~10 seconds. New service interval is set</p>

17.2 TROUBLE-SHOOTING AND EMERGENCY REMEDIES (Option “free contact”)

N.B. OPERATIONS MARKED ■ ■ MUST BE CARRIED OUT BY PROFESSIONALLY SKILLED PERSONNEL APPROVED THE MANUFACTURER

Disply	Flashing fault message	Description	Possible root causes	Observations
		Dryer is working OK	n/a	n/a
		Dryer is working OK	n/a	n/a
		Warning icon NOT flashing, label P1 flashing	Fan control probe failed	■■ replace probe
		Warning icon NOT flashing, label P2 flashing	PDP Temp probe failed	■■ replace probe
		Warning icon NOT flashing, label P3 flashing	Refrigerant compressor temperature probe failed	■■ replace probe
		Warning icon NOT flashing, label H2 flashing	High PDP	■■ refrigerant leak ■■ flow rate / inlet ■■ temperature exceeding the limit. ■■ call for service
		Warning icon NOT flashing, label L2 flashing	Low PDP	■■ hot gas by pass valve out of order. ■■ ambient temperature lower then limits ■■ call for service
		Warning icon NOT flashing, label H3 flashing	High refrigerant compressor temperature	■■ refrigerant leak ■■ call for service
		Warning icon NOT flashing, label H1 flashing	High temperature discharge condenser	■■ check probe ■■ call for service
		Warning icon NOT flashing, label L1 flashing	Low temperature discharge condenser	■■ check probe ■■ call for service

EE ALARM

EE alarm is shown when internal EPROM errors happens, if this warning will appear, the dryer will stop running. The error can be reset by pressing one of the four buttons of the controller, anyway please replace the controller itself.



NOTE: In case of EE alarm please contact your tech support.

SE ALARM

After 6000Hrs, the controller will issue a "SE" warning. This is the maintenance due warning.

**FREEZE PROTECTION FUNCTION**

Once the digital controller detects a dewpoint temperature below -2°C ($28,4^{\circ}\text{F}$) during more than 2 minutes (L2 Alarm), it switches off the refrigerant compressor.

AUTOMATIC CUT OUT OF REFRIGERANT COMPRESSOR

If the refrigerant temperature detected at the delivery pipe of refrigerant compressor overcome the limit setted by manufacturer, the controller stops the refrigerant compressor in order to avoid further possible failure.

COMPRESSOR RE-START AFTER A STOP

If freezing or superheating alarm occurs, the controller stops the compressor and the re-start has to be manually activated.

Before re-starting the dryer it is necessary to identify the root cause; such alarms indicate possible failure it is necessary to call customer center. Restart the dryer without a deep investigation on possible root cause will affect the reliability of the dryer and overrule the warranty reimbursement.

Press button Ref. 7 Fig. 9a to reset the alarm.













The dryer restarts when both the following conditions are satisfied:

- The dewpoint temperature is higher than -2°C ($28,4^{\circ}\text{F}$)









SILENT ALARM FUNCTION

To snooze the alarm, press button Ref. 7 (See Fig. 9a)

How to reset the maintenance warning: follow steps 1 to 12

<p>1</p>  <p>PDP is flashing between standard view and "SE" alarm</p>	<p>2</p>  <p>Push and hold buttons "SET" and "DOWN" to enter in the menu.</p>	<p>3</p>  <p>Message "SE" appears on display.</p>
<p>4</p>  <p>Push and release button "UP".</p>	<p>5</p>  <p>Message "rS" appears on display.</p>	<p>6</p>  <p>Push and release button "SET".</p>
<p>7</p>  <p>Message "n" appears on display.</p>	<p>8</p>  <p>Push and release button "UP".</p>	<p>9</p>  <p>Message "y" appears on display.</p>
<p>10</p>  <p>Push and release "SET" to reset service alarm.</p>	<p>11</p>  <p>Message "y" blinks for 3 seconds.</p>	<p>12</p>  <p>Then "rL" is fixed and "°C" blinks on display for ~10 seconds. Service alarm is reset</p>

PROCEDURE TO SET THE SERVICE INTERVAL ON PDP DEVICE

<p>1</p>	 <p>PDP is showing standard view.</p>	<p>2</p>  <p>Push and hold buttons "SET" and "DOWN" to enter in the menu.</p>	<p>3</p>  <p>Message "SE" appears on display.</p>
<p>4</p>	 <p>Push and release "SET" to enter in the "SE" menu.</p>	<p>5</p>  <p>Current service interval is displayed. ("60" or different value from "0" to "99")</p>	<p>6</p>  <p>Select desired service interval using "UP" or "DOWN". (40=4000h, 55=5500h, 80=8000h,...)</p>
<p>7</p>	 <p>Push and release "SET" to configure new service interval.</p>	<p>8</p>  <p>Value selected blinks for 3 seconds.</p>	<p>9</p>  <p>Then "rS" is fixed and "°C" blinks on display for ~10 seconds. New service interval is set</p>

18.0 STARTING UP



BEFORE CARRYING OUT ANY OPERATION ON THE MACHINE, ENSURE THAT THE ELECTRIC POWER SUPPLY HAS BEEN DISCONNECTED

18.1 PRELIMINARY CONTROLS

Before starting the dryer, check:

- The correct connection to the compressed air piping: remember to remove eventual caps on the drier inlet and outlet.
- The correct connection to the condensate drainage system.
- That the power supply is right.

18.2 STARTING AND STOP

Start the system before the air compressor starts running and stop it after the air compressor has been stopped. The compressed air piping will be free of condensate only by doing so. The drier must be kept running during all the time the air compressor is running. **WARNING:** if the drier is switched off, before starting it again, wait at least 5 minutes in order to allow the pressure balancing.

BEFORE CARRYING OUT ANY MAINTENANCE JOBS IT IS OBLIGATORY TO STOP THE MACHINE AND DISCONNECT IT FROM THE POWER MAINS AND FROM THE COMPRESSED AIR DISTRIBUTION NETWORK.

PRESSURE DISCHARGE PROCEDURE

Proceed as follows:

- Close the taps Ref. 1 Fig. 11
- Release the pressure in the dryer by pressing the condensate drain "TEST" pushbutton locate on the steam trap Ref. 1 Fig. 11
- Switch off the machine by pressing the STOP button Ref. 3 Fig. 11
- Turn on the supply automatic differential switch Ref. 4 Fig. 11

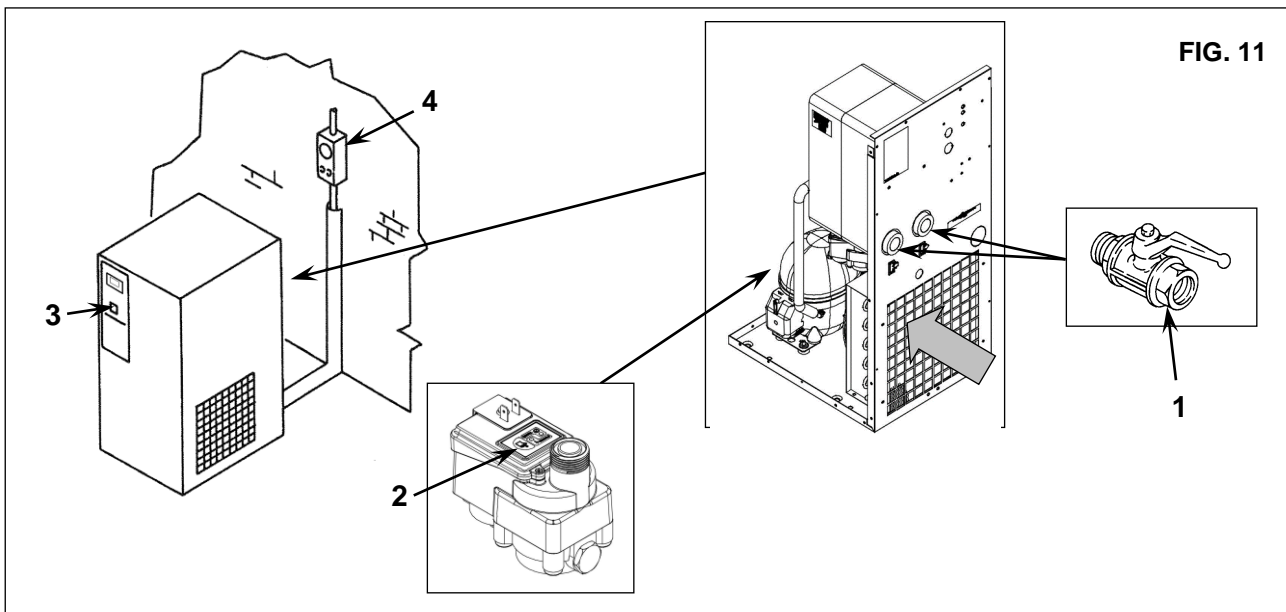

FIG. 11

**CALIBRATIONS
BYPASS VALVE FOR HOT GAS**

N.B. These valves have already been calibrated and they do not require any adjustment. A dew point different from the rated one generally depends on causes which are not attributable to their operation.

- Ref. 1) Closing cap
- Ref. 2) Adjusting screw

WORKING PRESSURES AND TEMPERATURES OF R513A

	SUCTION SIDE OF REFRIGERATION COMPRESSOR	
	Evaporat. Temperat. °C (° F)	Evaporating Pressure bar (psi)
RATED VALUES Temperat. 20 °C (68°F)	1 ÷ 2 (33,8 ÷ 35,6)	R513A 2,35 ÷ 2,47 (34,08 ÷ 35,82)

